

Wireless World

ELECTRONICS, TELEVISION, RADIO, AUDIO

Colour Television Standards

THE forthcoming meeting of the C.C.I.R. at the end of this month in Vienna to discuss, and this time we hope define, colour TV standards serves as yet another reminder that although we in this country have now had high-definition "penny plain" television on and off for thirty years, "twopence coloured" is still just around the corner. It has been there for the best part of ten years, ever since the Radio Corporation of America and the National Broadcasting Company put forward the blue print which was subsequently approved and endorsed by the Federal Communications Commission.

As an example of intellectual boldness and practical engineering achievement it ranks with the pioneering work in Great Britain of Schoenberg and his colleagues at E.M.I. and Marconi on the 405-line black-and-white system and will stand as a monument to American technical enterprise in the middle of the 20th century. It has been adopted in those countries which now boast regular colour television services.

With every incentive of commercial advantage and national pride as the spurs, no serious competitor has yet been found for the original shadow mask display device, though significant improvements have been evolved and proved in the coding and decoding circuitry which make the picture less vulnerable to transmission distortions. In particular the SECAM and PAL modifications developed in France and Germany respectively have earned the approval of the broadcasting authorities in many European countries. There are other detailed refinements which, although not backed by comparable publicity, carry sufficient merit to be included in any system in which the sponsors have a free hand to establish the service of their choice.

Which brings us to the questions of whether they should have a free hand or whether they must conform to a standard and if so, why?

It is axiomatic that the characteristics of a television transmitter (plain or coloured) should be known and not changed without notice, as these will impose standardization of all the receivers within range.

Beyond this further standardization may be convenient, but is not essential. As we extend our horizons for live (immediate) viewing the need for international standardization becomes more pressing (for the broadcasting authorities) but we are bound to ask if the fruits of such efforts as have been already made—immediacy in the occasional international song contest and some, but not all, of the broadcasts of Olympic games—are enough to justify many authorities in accepting a standard they do not like. Although tests under ideal conditions have shown that transmission of colour over long-distance circuits is possible, we doubt whether the quality can be maintained in day-to-day working with perhaps limited availability of the skilled personnel who conduct research demonstrations. One shudders to think what the present average black-and-white long distance hook-up with its frequent loss of sync, horizontal streaking, etc. will look like "in glorious Technicolor."

If only we would forego immediacy and allow time (a few hours at most?) for the development and transport of colour transparencies, future colour standardization need be only that imposed by the film makers. Given this common ground is there any point in trying to impose a general European standard for retransmission at the terminal centres? Does it matter how many standards there are provided that the original master images in the medium used for exchanges are line-free?

While feelings run high as the leading contenders near the receding winning post (now soon to be halted in Vienna?) may we suggest that in the event of a photo finish the stewards at this meeting should not declare a winner, but content themselves with recording the pedigree and form of the runners before returning them to their respective countries of origin to perform for the delight of the local inhabitants.

If agreement on a common standard can be reached in Vienna, well and good; but if it cannot, that by itself is no reason why any European country should not have a technically first-class colour television service forthwith.

**VOL 71 NO 3
MARCH 1965**

Tunnel Diode Measurements

SIMPLE METHODS FOR CHECKING CHARACTERISTICS OF LOWER SPEED DEVICES

By J. B. DANCE, M.Sc.

ALTHOUGH one might think that a tunnel diode characteristic could be plotted by employing the simple circuit of Fig. 1, the use of such a circuit will almost always result in the tunnel diode either oscillating or switching across a part of the characteristic. In either case the important negative resistance region (shown in Fig. 2) will be partly or entirely missed. This difficulty arises because at some parts of the characteristic there are three possible values of voltage for a particular current applied through the diode. In order to obtain the stability required for the plotting of the complete characteristic, the impedances used in the measuring circuit must be carefully chosen.

Simple Testing

Nevertheless the simple circuit of Fig. 1 can be used to obtain a general indication of a tunnel diode characteristic and to check that the diode under test has not been previously destroyed by heat or by excessive current. As the variable resistor R_2 is rotated to increase the potential across the diode, it will be found that the current increases relatively rapidly at first for potentials of the order of 0.05 volt. This is the region BC of the Fig. 2 characteristic. Quite suddenly, as the applied potential is further increased, switching will occur to the region DE. At this instant the potential across the diode rises to about 0.4 volt and at the same time the current falls somewhat owing to the circuit resistance. An approximate estimate of the diode peak current, I_p , can be obtained by noting the value of the current passing immediately before switching occurs and by multiplying this current by a factor of about 1.05. This factor is required, since it is not normally possible to reach the peak of the characteristic with the simple circuit of Fig. 1. As the peak is approached a stray noise pulse will cause switching to the DE region of Fig. 2. The voltmeter, V , should, of course, be a high-impedance instrument if the peak current of the diode is relatively small; a digital voltmeter is ideal.

While carrying out this test, care must be taken to ensure that the current passing through the diode does

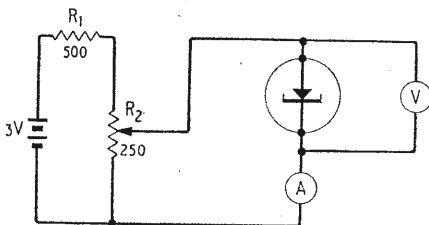

Fig. 1. Simple circuit for plotting tunnel diode characteristics.

not exceed the maximum value recommended by the manufacturers. This is often of the order of $10 I_p$. Thus some tunnel diodes with an I_p value of 1 mA should not be allowed to pass more than 10 mA.

The reverse characteristic can also be plotted using the circuit of Fig. 1. Even greater care is necessary to prevent the maximum current rating being exceeded than when the forward characteristic is being examined, since in some cases the maximum current rating can be exceeded at an applied potential of less than 0.1 volt.

Another simple circuit which may be used to estimate

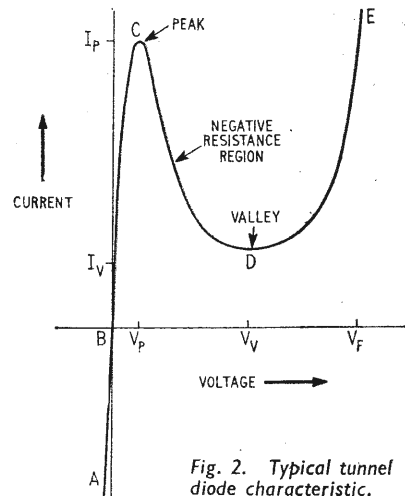

Fig. 2. Typical tunnel diode characteristic.

the peak current of a tunnel diode is shown in Fig. 3. A half-wave rectified voltage is applied to the diode. As R_1 is reduced, the maximum current passing through the diode in each alternate half cycle increases until the trace on the oscilloscope shows that the diode is switching. The voltage across R at which this first occurs can be measured by means of the oscilloscope and hence the maximum current passing through R can be found. This is approximately equal to the tunnel diode peak current.

Equivalent Circuit

The conditions under which a tunnel diode is stable in the test circuit can be deduced from the small-signal equivalent circuit of the device; if these conditions are satisfied, the whole of the characteristic can be examined. In the negative resistance region of the characteristic, a tunnel diode may be represented by the small-signal equivalent circuit of Fig. 4. The negative resistance, $-r$, is the reciprocal of the slope of the negative resistance

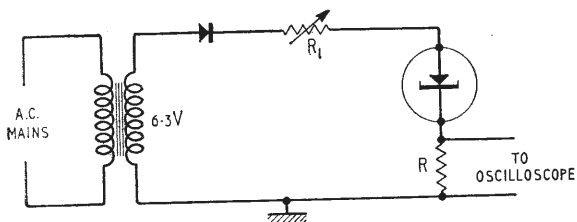

Fig. 3. Circuit for estimating peak current of diode.

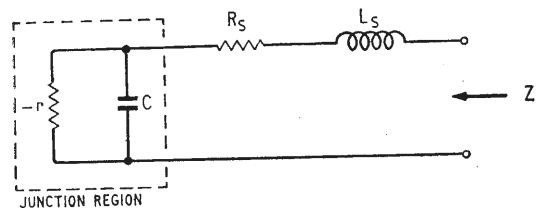

Fig. 4. Small-signal equivalent circuit in negative-resistance region of diode characteristic.

region of the characteristic. The parameter C is the capacitance across the p-n junction of the diode. Both $-r$ and C vary somewhat with the voltage applied to the diode. The negative resistance quoted in data sheets is the reciprocal of the maximum slope of the negative resistance region of the diode characteristic. Junction capacitance is normally measured in the valley region. The components R_s and L_s are the resistance and inductance of the semiconductor material and of the leads which connect the junction to the external circuit.

Stability Conditions

Two conditions must be satisfied if the tunnel diode is to be stable through the negative resistance region of the characteristic. The first condition to be discussed must be satisfied if switching is to be avoided, while the second condition is concerned with oscillation.

If the diode under test is connected to a circuit of relatively high internal resistance, the load corresponding to this resistance will cut the tunnel diode characteristic

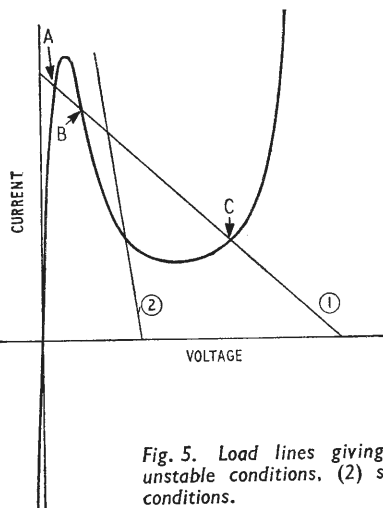

Fig. 5. Load lines giving (1) unstable conditions, (2) stable conditions.

in three places, A, B and C in Fig. 5. Point B is unstable, since any increase in the potential across the diode will result in a smaller current passing through it. A still larger voltage will therefore appear across the diode owing to the internal resistance of the supply. Thus the effect of a small change is cumulative and the diode will quickly switch from B to either A or C. In order to avoid this switching instability, the effective resistance connected across the diode must have a value such that the load line representing the resistance cuts the diode characteristic at only one point. The load line marked 2 in Fig. 5 satisfies this condition.

Switching will therefore not occur if the resistance connected across the tunnel diode junction is numerically less than $-r$. Thus if the total series resistance of the circuit is R , the condition for the absence of switching is

$R < |-r|$ Condition (1)
 R_s is usually much smaller than $|-r|$; it is therefore approximately true to say that switching will not take place if the resistance connected across the diode terminals is less than $|-r|$.

Oscillation Conditions

The maximum frequency at which a tunnel diode can oscillate may be calculated from the equivalent circuit of Fig. 4. The impedance, Z , across the diode terminals is given by:—

$$Z = R_s + j\omega L_s + \frac{1}{j\omega C - \frac{1}{r}}$$

Separating the real and imaginary parts of this expression:—

$$Z = R_s - \frac{1}{r} \left\{ \frac{1}{\omega^2 C^2 + \frac{1}{r^2}} \right\} + j\omega \left\{ L_s - \frac{C}{\omega^2 C^2 + \frac{1}{r^2}} \right\}$$

Oscillation will be sustained only if the real part of this expression is negative, that is, if

$$R_s < \frac{1}{r} \left\{ \frac{1}{\omega^2 C^2 + \frac{1}{r^2}} \right\}$$

The maximum value of ω which satisfies this condition, ω_c , is thus given by:—

$$\omega_c = \frac{1}{r C} \sqrt{\frac{r}{R_s} - 1}$$

The maximum possible frequency of oscillation is $f_c = 2\pi\omega_c$ and is known as the resistive cut-off frequency. At higher frequencies the tunnel diode attenuates any small changes in potential, since its effective resistance is no longer negative. The resistive cut-off frequency cannot be measured experimentally.

In practice the maximum frequency of oscillation may be limited by the minimum series inductance connected across the junction. The smallest value of series inductance occurs when the diode leads are effectively shorted and equals L_s . At this self-resonant frequency, the reactive part of the expression for Z becomes zero.

Hence

$$L_s = \frac{C}{\omega_r^2 C^2 + \frac{1}{r^2}}$$

$$\text{or } \omega_r = \frac{1}{C} \sqrt{\frac{C}{L_s} - \frac{1}{r^2}}$$

For some tunnel diodes the self-resonant frequency, f_r , is less than f_c . If such a device is placed in a case with

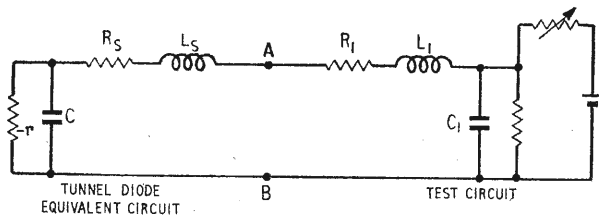

Fig. 6. Basic circuit of tunnel diode and its test equipment.

lower inductance, however, it may be possible to reduce L_s and hence to increase f_p , so that f_p is greater than f_c . In this situation the device is short-circuit stable.

The basic circuit of a tunnel diode and its test equipment is shown in Fig. 6. The tunnel diode equivalent circuit is shown on the left of the diode terminals A and B and the test circuit on the right of these points. R_1 and L_1 represent the unavoidable resistance and inductance of the connecting leads and may be added to R_s and L_s . The total series inductance and resistance in the circuit will be given the symbols L and R respectively. C_1 is the decoupling capacitor. If only alternating currents are considered, the series resonant circuit of Fig. 6 may be replaced by the equivalent parallel resonant circuit of Fig. 7. C_1 of Fig. 6 is normally much greater than the junction capacitance, C , and therefore the effective tuning capacitance differs little from C . This capacitance is therefore shown in Fig. 7.

Oscillation will occur if the dynamic load line cuts the diode characteristic in three places, that is, if the dynamic

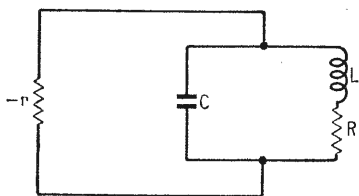

Fig. 7. Parallel resonant circuit equivalent to series resonant circuit in Fig. 6.

impedance of the tuned circuit of Fig. 6 exceeds $|-r|^{(1)}$. Thus the dynamic load line must be similar to that marked 1 in Fig. 5, but the static load line must be similar to that marked 2 if oscillation is to occur. The dynamic impedance of the tuned circuit of Fig. 7, Z_D , is given by:—

$$Z_D = QX_C = \frac{2\pi fL}{R} \cdot \frac{1}{2\pi fC} = \frac{L}{RC}$$

For stability $Z_D < |-r|$

That is $L < RC|-r|$ Condition (2)

If L is only slightly greater than $RC|-r|$, the oscillations are confined to the negative-resistance region and are approximately sinusoidal. If L is large, however, the instantaneous diode voltage and current show excursions into the region where the diode resistance is positive and relaxation oscillations occur.

If switching is to be avoided it is essential that the total series resistance of the circuit, R , shall not exceed $|-r|$. On the other hand R should not be very much smaller than $|-r|$ or the circuit will not be sufficiently damped and the second condition will be more difficult to satisfy. The series inductance of the measuring circuit to which the tunnel diode is connected must be kept as small as possible. The circuit values to be used for measuring

the characteristics of a tunnel diode will depend upon the parameters of the diode itself.

Practical Example

Let us assume that it is required to determine the characteristics of an S.T.C. JK9B tunnel diode. The nominal peak current of this type of diode is 1 mA, the negative-resistance parameter has a minimum value of about -110 ohms and the junction capacitance is about 25 pF. The circuit of Fig. 8 has been found suitable for plotting the characteristic (shown in Fig. 9) of diodes of this type. The value of the effective resistance connected in series with the tunnel diode terminals varies somewhat with the setting of R_2 , but will normally be between the limits of 50 and 80 ohms over the negative-

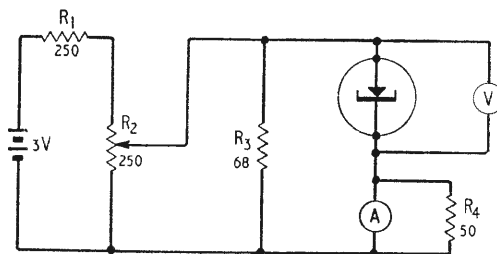

Fig. 8. Arrangement used for plotting characteristics of type JK9B tunnel diode.

resistance region of the tunnel diode characteristic. This satisfies Condition 1, but if oscillation is not to occur

$$L < CR|-r|$$

Assuming R is 50 ohms

$$L < 25 \times 10^{-12} \times 50 \times |-120|$$

$$L < 0.15 \mu\text{H}$$

This condition that the total series inductance across the tunnel diode junction shall be less than 0.15 microhenry is not difficult to satisfy. The series inductance of the JK9B is of the order of $L_s = 6 \times 10^{-9}$ henry and is negligible compared with 0.15 microhenry.

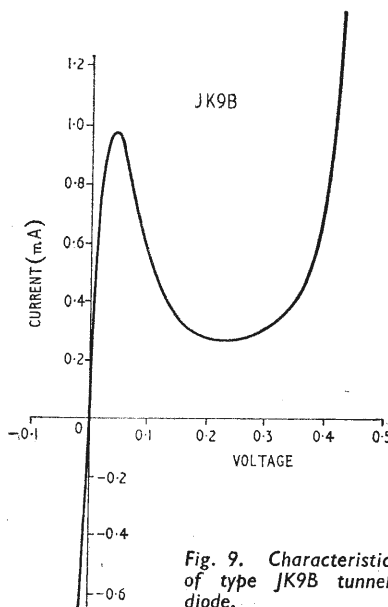

Fig. 9. Characteristic of type JK9B tunnel diode.

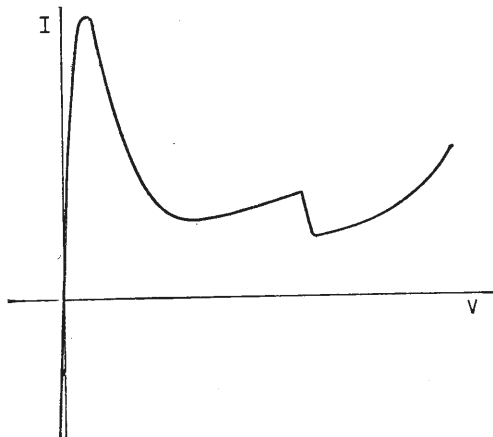

Fig. 10. Typical characteristic resulting from oscillation in measuring circuit.

A relatively sensitive meter was used for measuring the tunnel diode current, but it was shunted by a 50-ohm carbon composition resistor in order to reduce the effective inductance of the circuit. The meter and its shunt were calibrated against an ammeter; a full-scale deflection of about 1.3 mA is convenient for use with a 1-mA tunnel diode. The tunnel diode, R_3 and R_4 were joined directly together with short leads in the form of a small triangle. It is important that R_3 and R_4 should have a low inductance. A valve voltmeter was employed to measure the potential across the diode. As an experiment a multirange meter was substituted for A and its 50-ohm shunt, but much of the negative-resistance region was then missed owing to the meter inductance. Similarly if R_3 is omitted it is not possible to plot the whole characteristic.

Sometimes a curve of the type shown in Fig. 10 is obtained which appears to have two negative resistance regions. In this case oscillation is taking place and an additional rectified current is automatically superimposed on the diode characteristic². If care is taken to minimise the circuit inductance, this trouble can usually be avoided with tunnel diodes of relatively low speed.

High Speed Diodes

The type of circuit shown in Fig. 8 may be used for tunnel diodes which have somewhat larger peak currents. The values of the negative resistance of these diodes will normally be smaller than that of 1-mA diodes, however, and the resistor values employed in the circuit must therefore be reduced. It may prove difficult to achieve stability.

With some tunnel diodes it is not possible to achieve stability in the negative-resistance region of the characteristic when any type of circuit is used. Let us consider, for example, a tunnel diode with a negative resistance of 1 ohm and a junction capacitance of 20 pF. If switching is to be avoided, the maximum effective value of the series resistance connected across the diode terminals is 1 ohm.

To avoid oscillation

$$L < CR|-r|$$

$$L < 20 \times 10^{-12} \times 1 \times 1$$

$$L < 2 \times 10^{-11} \text{ henry}$$

The inductance, L_s , of the diode itself will probably exceed this value and stability is then impossible.

In most cases it will be possible to achieve stability, but

the tunnel diode may have to be placed in a special low-inductance holder which contains a resistor of extremely low inductance connected across the diode. The holder may be in the form of a small cylinder divided into two sections which surround the diode. The two sections of the cylinder are joined by the resistor, which is often constructed as a thin slab but may take the form of an annulus placed round the diode. Low-inductance germanium resistors are sometimes used. In this way the series inductance connected across the diode may be reduced to a very small value. A capacitor may also be connected across the diode.

The characteristic of a tunnel diode mounted in this way may be plotted by use of the circuit in Fig. 11. The ammeter indicates the total current passed by the parallel combination of the diode and the stabilizing resistor R_3 which is mounted inside the tunnel diode holder. In order to derive the diode characteristic, it is therefore necessary to subtract the current passing through R_3 from the total current indicated by the ammeter.

The Fig. 11 circuit is also useful for finding the negative resistance parameter of a tunnel diode. If R_3 exceeds $|-r|$ the type of curve shown in Fig. 12(a) is obtained. If R_3 is less than $|-r|$ the current increases continuously with the applied voltage as shown in Fig. 12(b). When R_3 is made exactly equal to $|-r|$ the positive resistance of R_3 cancels the negative resistance of the diode over the portion of the curve where the negative resistance is a minimum. At this point the curve is horizontal as shown in Fig. 12(c).

When the circuit of Fig. 11 is to be used to determine the negative resistance of a tunnel diode by the method described in the preceding paragraph, it is necessary to be able to vary R_3 . A variable resistor cannot be employed, since most variable resistors have a high inductance. There is, however, no objection to the use of a low-

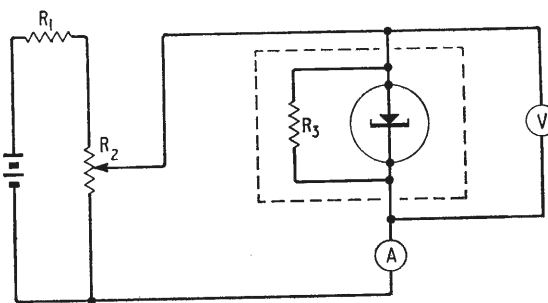

Fig. 11. Plotting characteristics of diode with stabilizing resistor within low-inductance holder.

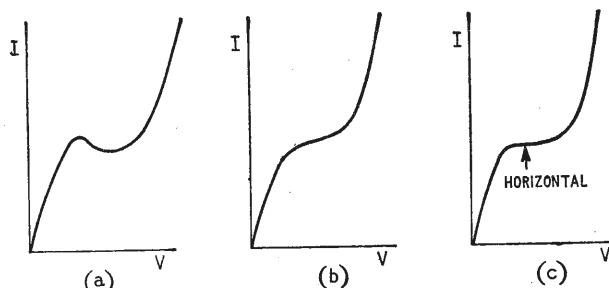

Fig. 12. Curves obtained with different values of stabilizing resistor*

inductance fixed resistor of a value somewhat greater than $| -r |$ in parallel with a variable resistor. With high-speed diodes the fixed resistor should be mounted in the diode holder, but for low-speed devices a carbon composition resistor connected directly across the diode terminals will be satisfactory. The value of the variable resistor is adjusted until a point is found, on rotation of R_2 in Fig. 11, at which the current remains constant with increasing voltage; this is the horizontal portion of the curve in Fig. 12(c). The resistance of the parallel combination of the fixed and variable resistor is then found and is equal to the negative resistance of the diode.

Curve Tracers

It is often very convenient to be able to display the characteristic of a tunnel diode on a cathode-ray tube. Instability must be avoided if the whole of the negative-resistance region is to be displayed. A simple type of circuit for displaying the characteristics of low-speed tunnel diodes is shown in Fig. 13. The voltage across R_3 is proportional to the tunnel diode current and is displayed on the Y axis. ($R_2 + R_3$) should be slightly less than $| -r |$. The transformer secondary voltage should be about 2 to 10 volts.

If a linear saw-tooth waveform is applied to a tunnel diode in the Fig. 13 circuit instead of rectified a.c., the voltage across R_3 may be differentiated with respect to time and applied to the Y plates of the cathode ray tube. The resulting curve will show how the conductance of the diode (including that in the negative-resistance region) varies with the applied voltage⁵.

The characteristics of fairly high speed tunnel diodes may be displayed on a cathode-ray tube by means of the bridge circuit Fig. 14. The tunnel diode may, if necessary be mounted in a very low inductance holder which contains the parallel stabilizing resistor, R_2 . Initially the tunnel diode is disconnected and the 500-ohm potentiometer is adjusted so that no vertical deflection occurs as the trace passes across the screen of the cathode-ray tube. The bridge is now balanced. When the tunnel diode is placed in the circuit its characteristic will be displayed, since the current passing through R_2 will be effectively cancelled out by the bridge circuit. Only the unbalanced current passing through the tunnel diode will cause a vertical deflection.

Series Resistance

The series resistance of a tunnel diode, R_s , is usually obtained from its reverse characteristic. Its value is taken to be the reciprocal of the slope of the current/voltage curve in the reverse region at an appreciable reverse current where the characteristic is substantially linear. A reverse current of ten times the peak current may

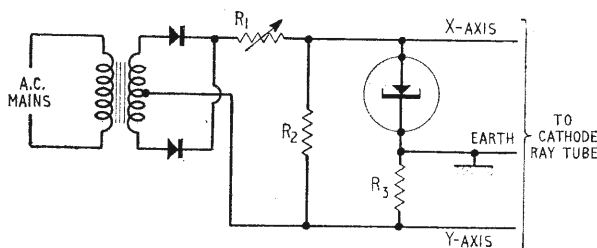

Fig. 13. Scheme for displaying characteristics of low-speed diodes on a cathode-ray tube.

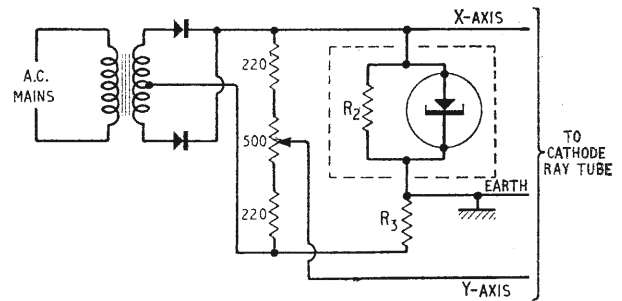

Fig. 14. Characteristics of fairly high speed diodes can be displayed on a c.r.t. with this circuit.

usually be used without causing damage to the narrow p-n junction.

It is not normally necessary to determine R_s to a high degree of accuracy. If an accurate value is required, the slope of the reverse characteristic is measured at a fairly high current by a pulse technique⁶. The duration of the pulses are chosen so that they do not cause excessive heating.

Other Measurements

The junction capacitance of a tunnel diode varies with the applied voltage. It is normally measured by means of a bridge with the tunnel diode biased in the valley region where its a.c. resistance is infinite. If a measurement is made at a point where the a.c. resistance is not infinite, an analysis of the equivalent circuit shows that an allowance must be made for the effect of the other diode parameters on the measured capacitance value. The a.c. resistance is also infinite at the current peak, but the bias voltage is much too critical for capacitance measurements to be carried out easily and reliably at this point. Even in the valley region the a.c. voltage applied to the diode by the bridge measuring circuit should be small, preferably not more than about ten millivolts. Measuring frequencies of ten to one hundred megacycles are often used.

The junction capacitance in the valley region is somewhat different from that in the negative resistance region. Capacitance measurements can be made in the negative-resistance region, but are not so easily carried out⁴.

The measurement of the series inductance, L_s , of a tunnel diode is difficult, since its value is very small. Microwave techniques are employed⁴. Fortunately L_s is fairly constant for any one type of tunnel diode and the manufacturer's figure can usually be relied upon.

Acknowledgement

The writer is indebted to Messrs. Standard Telephones & Cables Ltd. (Semiconductor Division) who kindly provided some tunnel diodes for experimental work.

REFERENCES

1. U.S. Davidsohn, Y. C. Hwang and G. B. Ober, "Designing with Tunnel Diodes". *Electronic Design*, 3rd Feb., 1960.
2. "Die Tunneliode. Kenngrößen und deren Messung". Telefunken report 6112 81.
3. "Technical Report on Tunnel Diode Measurements". Sylvania publication 9162G163.
4. "RCA Tunnel Diode Technical Manual". RCA publication TD-30.

Correcting Colour Signal Distortion

AUTOMATIC DIFFERENTIAL GAIN AND PHASE CORRECTION FOR LONG-DISTANCE COLOUR TELEVISION LINKS

By I. F. MACDIARMID,* A.M.I.E.E., and
I. J. SHELLEY,† A.M.I.E.E., A.M.I.E.R.E.

IN an N.T.S.C. colour television system the luminance information consists of a wideband video signal similar to a conventional monochrome signal and the chrominance information is conveyed as phase and amplitude modulation of a subcarrier—4.43 Mc/s in Europe. The modulation is arranged such that the colour saturation determines the subcarrier amplitude and the hue controls the subcarrier phase relative to a colour synchronizing burst transmitted at the start of each line.

It is well known that the composite colour signal is particularly sensitive to the effects of non-linearity distortion; variations of the luminance signal cause unwanted changes in the amplitude and phase of the colour subcarrier. These distortions are generally known as "differential gain" and "differential phase" respectively and at the present time the long-distance links which form both national and international distribution networks are major contributors of these types of distortion.

The signal transmission path in a long-distance link normally includes a number of a.c. couplings and consequently the part of the non-linear transfer characteristic occupied by a picture signal changes with the d.c. component of the signal. When a picture signal, other than a test pattern or still picture, is transmitted over a chain of tandem-connected links, the differential gain and differential phase distortions will vary with time in a complicated manner depending on the changes in the d.c. component of the picture, the non-linear transfer characteristic of each link and the long-term transient response of each link. Quite clearly it is not possible to provide a fixed corrector to deal with these types of distortion.

In a recent letter to *Electronics and Power* (June 1964, p. 207) Dr. N. W. Lewis suggested the use of a subcarrier pilot signal which could be added to an N.T.S.C. waveform in order to provide a means whereby the values of differential phase and gain distortion occurring on two discrete luminance levels could be determined.

* Post Office Research Station.

† B.B.C. Designs Department.

Since this article was prepared an automatic corrector for both differential phase and gain distortions has been produced and the authors recently visited Moscow where the equipment was demonstrated. N.T.S.C. pictures were transmitted over a 4,500 km link between London and Moscow and over numerous very long distance monochrome links within the Soviet Union. Apart from the inevitable reduction in overall signal-to-noise ratio the corrected N.T.S.C. signals are reported to have shown very little degradation in quality after transmission over these long links.

This information, if extracted in suitable form could be used to control a corrector such that the overall distortion on a chain of links could be held within acceptable limits.

A new corrector circuit which is particularly suited to the automatic correction of differential phase and gain has been developed at the Post Office Research Station, and this corrector has been incorporated in an experimental subcarrier pilot system which was recently demonstrated by the B.B.C. during a meeting of the European Broadcasting Union Ad Hoc Colour Television Group and Sub-groups.

The subcarrier pilot signal used in the experimental system is shown in Fig. 1. The pilot burst, consisting of 5 cycles of subcarrier, is added to a pedestal the amplitude of which alternates between peak white and grey (50% peak white amplitude)—two lines at peak white and two lines at grey. The pilot burst and the

Fig. 1. Specification of experimental colour pilot signal. The pilot burst alternates in position, two lines on a white pedestal and two lines on a grey pedestal.

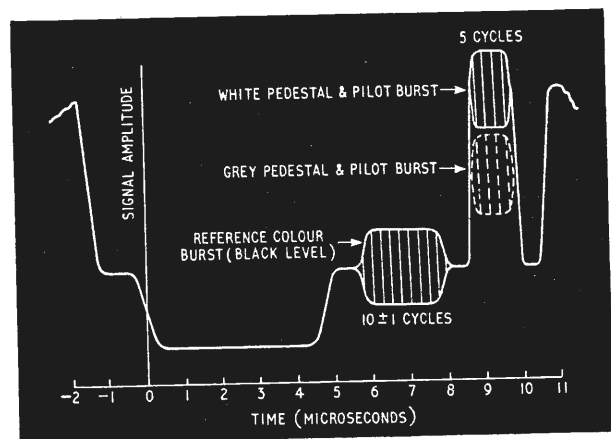

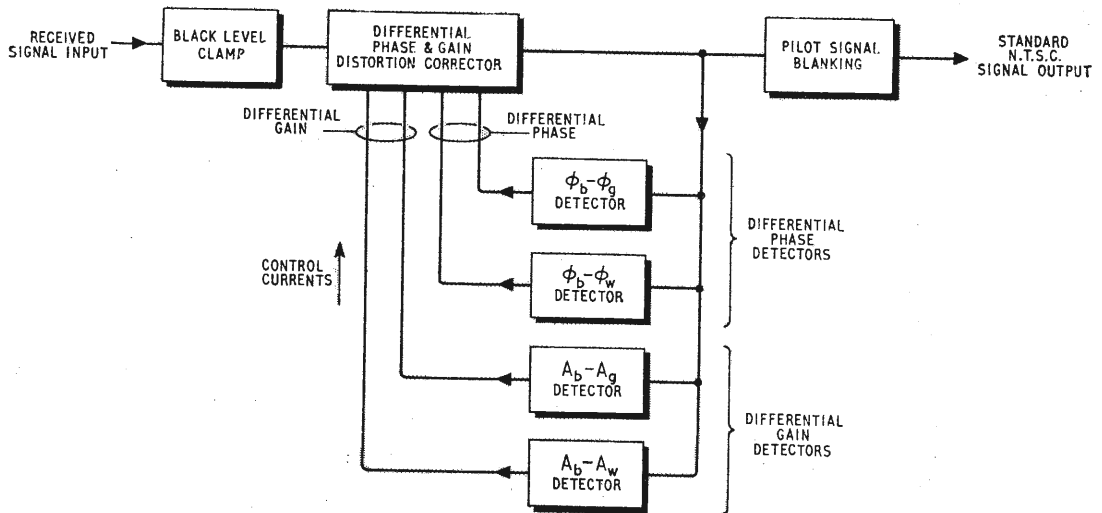

Fig. 2. Automatic corrector for differential phase and gain distortion. ϕ_b, A_b are mean phase and amplitude of colour burst (black level); ϕ_g, A_g are mean phase and amplitude of pilot burst on grey pedestal; ϕ_w, A_w are mean phase and amplitude of pilot burst on white pedestal.

pedestal are suppressed during the field equalizing and broad pulse periods.

This pilot signal can be added to the standard N.T.S.C. waveform without any reduction of the active line period. It does not interfere with the synchronising, colour burst or black level reference signals in the waveform, and the information conveyed by the pilot signal is sufficient to allow its satisfactory extraction under the conditions of noise and waveform distortion which may exist at the end of a long chain of links.

The basic principles of the automatic corrector using the subcarrier pilot signal are shown in Figs. 2 and 3. The received signal passes through a black level clamp and the differential phase and gain corrector before being applied to differential phase and gain detectors and a pilot-signal blanking unit. The black level clamp is necessary to enable the corrector to operate at luminance levels corresponding to the grey and white pedestal amplitudes; the pilot signal blanking unit removes the pedestals and pilot bursts from the signal, thereby restoring it to its original standard N.T.S.C. form.

The corrector (Fig. 3) provides variable differential phase and gain characteristics whose shapes may be adjusted by means of four control currents. The input video signal is applied to the centre point of the tapped winding of a hybrid transformer and the signal splits between a resistor network, X, which can initially be assumed to be a resistor balancing the hybrid, and a delay network. The last-mentioned part of the signal, which will be called the main signal, after passing through a level-adjusting pad, is applied to the centre point of a second hybrid transformer where it splits between a balancing resistor and the output terminals. Because both hybrids are operating under balanced conditions, the transformer cores are not magnetized and the frequency response of the path just described extends down to zero frequency.

If the value of the resistor at X is now changed by a small amount, part of the input signal is reflected back into hybrid No. 1 where it splits between the input circuit and a constant-resistance filter; none of this reflected signal reaches the delay network. The filter selects the

components of the reflected signal in the chrominance-channel band and these form a correcting signal which is added in hybrid No. 2 to the main signal. Considering the subcarrier, if the correcting signal is in phase or in anti-phase with the main signal it will cause only an amplitude change. If the correcting signal is in phase-quadrature with the main signal it will cause a phase change (with little accompanying amplitude change if the correcting signal is not too large). The delay network is provided so that the required phase relationships can be established in the output circuit.

If X is a voltage-dependent resistor which gives a reflection coefficient of zero when the video signal voltage is at blanking level, and a positive or negative reflection coefficient (as required) at voltages above blanking level, the circuit can be used as a corrector for either differential gain or phase according to the delay value chosen for the delay network.

The magnitude and sign of the reflection coefficient at grey and white luminance levels is controlled by means of currents passed into the voltage-dependent resistor network, which is an assembly of semiconductor diodes. The control currents are derived by extracting the relevant information from the pilot signal by means of the four detectors shown in Fig. 2. The upper two detectors compare the phase of the colour burst (black level) with the phase of the pilot burst on the grey and white pedestals respectively while the lower two detectors compare the respective amplitudes. The four currents are fed into the control points in the corrector such that it introduces the appropriate amount of differential phase and gain distortion at grey and white level in the opposite sense to the original distortion; the overall amount of correction which can be achieved depends upon the loop feedback characteristics of the detectors and the corrector. It is assumed that the curves of differential phase and gain distortion will be roughly parabolic in shape and that correction at the grey and white levels will produce a

‡ This method of using hybrid transformer networks for video signals is an extension of a method devised by Dr. J. M. Linke for use in a corrector for linear waveform distortion.

satisfactory characteristic over the whole of the signal amplitude. In practice this assumption appears to be fully justified.

The experimental system, confined to the automatic correction of differential phase distortion, was tested both on simulated long-distance links in the laboratory and on looped Eurovision links which are normally used for monochrome transmissions between London and Brussels (660 km) and London and Rome (4,300 km).

A colour-bar test signal, studio camera pictures and pictures obtained from a high grade colour telecine machine were transmitted round the various links and observed on a colour monitor. A special effect was used in the studio to produce rapid changes of the d.c. component of the colour signal, causing the signal to be subjected to the full range of differential phase and gain distortion present on the circuit.

The pictures as received were unacceptable, showing clearly recognizable distortion of hue. After automatic correction these defects were reduced to an acceptable level and hue differences between the transmitted and corrected pictures were only just perceptible. A change in grey scale and some desaturation of the colour picture was noticeable due to the line-time non-linearity and differential gain distortion which were present on the links and remained uncorrected.

The tests carried out with the experimental system have demonstrated the practicability of adding a sub-carrier pilot signal to an N.T.S.C. waveform and extracting at a distant point information which can be used to control an automatic corrector. The experimental pilot signal can be inserted into and removed from the standard N.T.S.C. waveform with little difficulty.

With the majority of differential phase distortions tried (including the tests made on the looped London-Brussels and London-Rome links) automatic correction has resulted in a reduction of the magnitude of the distortion of between two-and-a-half and seven times. The performance of the experimental system under poor signal-

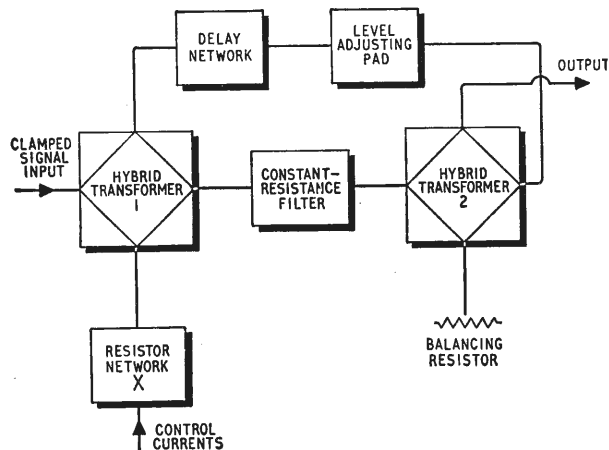

Fig. 3. Simplified schematic of differential phase and gain corrector.

to-noise conditions has been investigated and the tests have shown that the system is only likely to fail when the level of noise is such as to render the received colour signal unusable.

Although these investigations have been concerned mainly with the problems of the long-distance transmission of N.T.S.C. colour signals the automatic corrector could also be applied to the correction of the differential phase and gain distortion introduced in television transmitters. The pilot signal could be inserted for a short period at regular intervals and the error signals used to control the corrector through a motor drive system.

Acknowledgement is made to the Engineer-in-Chief of the Post Office and to the Director of Engineering of the B.B.C. for permission to make use of the information included in this article.

Further Notes on the

Wireless World Transistor F.M. Tuner

SINCE constructional details for this crystal-controlled, pulse-discriminator unit were given in the July 1964 issue we have received many useful comments from readers who have successfully built this tuner. Where difficulty has been experienced it has usually been concerned with the setting up of the various pre-set controls, and for the benefit of others who may be encountering some of the commoner problems we append a few notes which may help.

(1) We would reiterate that the total current consumption of the unit should lie between 13-15 mA, not 7 mA as originally stated.

(2) The supply voltage should not be allowed to fall below 7 V or distortion on high deviations will become apparent.

(3) L6 and L7 inductances are 3 mH.

(4) To ensure that the tuner is working at its maximum sensitivity, the following procedure should be carried out:—

Connect to a good Band II aerial. Switch to the highest frequency programme and unscrew the core of T1 completely. Now screw in the core of T1 until the programme is received and then screw the core in one more turn. The approximate setting is about 3 turns out from the top of the former. Now check that the oscillator still functions on the other programmes.

Switch to the middle frequency programme. Reduce the aerial signal until noise becomes apparent on the output. Tune L2 core until the noise ceases. Repeat these adjustments until no further improvement is obtained. Still with the aerial signal small enough to produce noise on the output, adjust T1 coupling coil position as follows:—

Move the coupling coil up or down the former until the noise ceases, then reduce the aerial signal still further and again position the coil for minimum noise. Repeat this operation until no further improvement is obtained.

ELECTRONICS IN THE METEOROLOGICAL OFFICE

By C. E. GOODISON

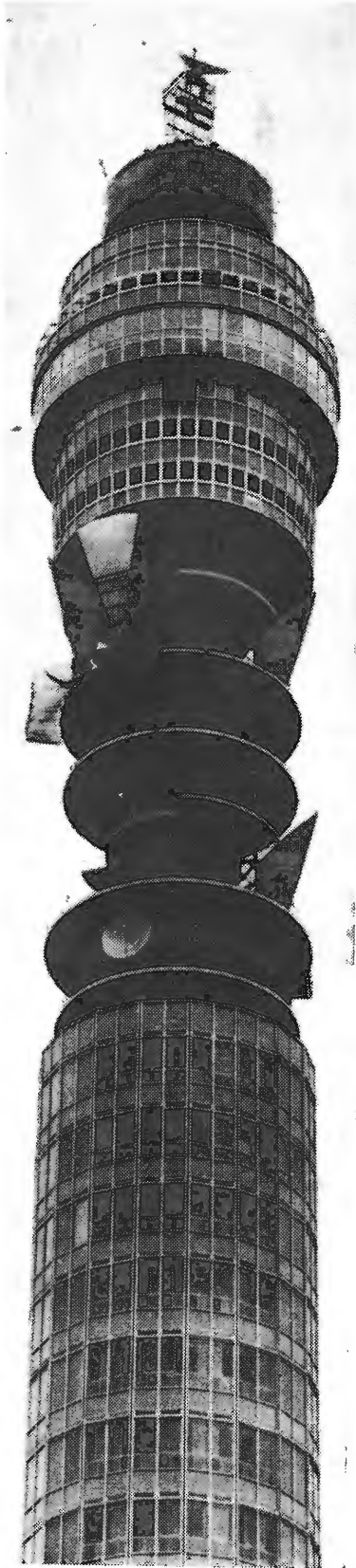

NEW electronic and electrical instruments are in the process of being introduced into service within the Meteorological Office. These cover a very wide range of size and application, from a fast digital computer, the KDF9 costing about £400,000, to a small temperature bridge unit which will be used in an automatic weather station and costing about £20. Some of these instruments have been designed by the Meteorological Office and others have been designed and produced by manufacturers to Meteorological Office specifications.

Computer:—The new computer, code named in the Meteorological Office “COMET,” will replace an earlier type, which has given good service in the past but is proving too slow for some of the new programmes now being developed by Meteorological Office programmers for forecasting and other purposes. The KDF9 is an extremely fast and versatile machine and should cater for all the many uses being planned for it by various departments in the Office. These plans include widening the basis of the present daily weather forecast so that more data may be used and therefore greater accuracy may be achieved. At present the “numerical” forecast takes about 4½ hours to prepare. With “COMET” this time will be cut to 20 minutes. Climatologists in the Meteorological Office will process and extract more data than is possible with the existing computer, and radiation records from new data loggers will be analysed very rapidly.

Radar:—The second generation of wind-finding radar sets is now being delivered. These sets have twice the range of the old war-time radar now in use and incorporate auto-follow as a standard facility. With such a performance these will enable wind velocities at altitudes up to 80,000 feet to be obtained. The new radars will be housed permanently at upper-air sounding stations in U.K. and at overseas bases. The first, already delivered to the Office is now installed at South Uist in the Outer Hebrides where meteorological rockets are being launched to probe the weather conditions up to 200,000 feet.

A network of weather radars for the location of precipitation is in the process of installation and at certain public weather centres throughout the U.K. 3cm weather surveillance radars will be fitted. These sets should improve short-term forecasting of rain since they will provide the forecaster with a visual and easily interpreted picture of the progress of precipitation across his immediate area of responsibility. The first installation will be atop the new high G.P.O. Tower in London to serve and be controlled from the London Weather Centre in High Holborn.

Cloud Base Recorders:—Electronic instruments for measuring the cloud height have been in operation at many airfields throughout the world for some time and

The scanner of one of the Decca Type 42A radars used by the Met. Office is installed on the 40-ft mast at the top of the 580 ft Post Office Tower near Tottenham Court Road, in central London. The radar transmitter is remotely controlled from the London Weather Centre three-quarters of a mile away.

the Meteorological Office is extending their use in the near future to a large number of airfields in the U.K. This British-made device works on the triangulation principle and depends on the use of light interrupted at 900 c/s for the detection of a light spot on the cloud base during night and day. The receiver is fixed and sighted vertically while the transmitter beam swings over an arc from 5° to 85° from the horizontal. A tuned amplifier, plus a phase-sensitive detector provides sufficient sensitivity to give a clear signal from a spot of chopped light which may be millions of times weaker than the ambient daylight at the lead sulphide detecting cell. The record produced by the instrument takes the form of a series of strokes on an electro-sensitive paper chart which is moved along at three inches per hour. The strokes are made by a stylus which moves up and down the chart once a minute in synchronism with the examining searchlight. When cloud is present a voltage from the detector is applied to the stylus tip and marks the chart.

The range of the equipment, normally 50 to 4,000 feet is chosen to cover the cloud base height interval which is of immediate interest in aircraft operations near airfields. Five pilot production models have now completed more than 60,000 hours of service and the validity of readings has been investigated by several methods, e.g. night cloud searchlights, pilot balloons and pilots' reports, and found to be satisfactory.

Automatic Weather Stations:—The first production pro-

totype of an automatic weather reporting system is on test at the Meteorological Office, Bracknell. Various transducers are located at an experimental site some three miles from the headquarters building and the "sender" is linked by a single telephone line to the receiver in the headquarters building. The meteorological elements being monitored include atmospheric pressure, temperature, wet bulb depression (which in combination with temperature provides a measure of relative humidity) total rainfall, rate of rainfall, mean wind speed and direction, sunshine and visibility. The different transducers necessary to translate these parameters into voltages suitable for use by the telemetering apparatus, have been developed by the Meteorological Office and experimental models built and tested. Small numbers are now being made by contractors and will be available for projects where voltages, linearly proportional to these various meteorological parameters, are required for display or input to other systems.

One rather novel transducer is a sunshine detecting device, which operates by rotating a dome with opaque sectors round a photo transistor. In bright sunshine, the shadows cast by these sectors cause voltage waveforms to be produced by the photo transistor. These voltages are then fed to an electrical differentiating circuit which produces small narrow pulses whose amplitude depends on the steepness of the leading edge of the waveform at the output of the photo transistor. When the shadows are sufficiently well defined a trigger circuit operates a relay. This relay closure may then be used to provide

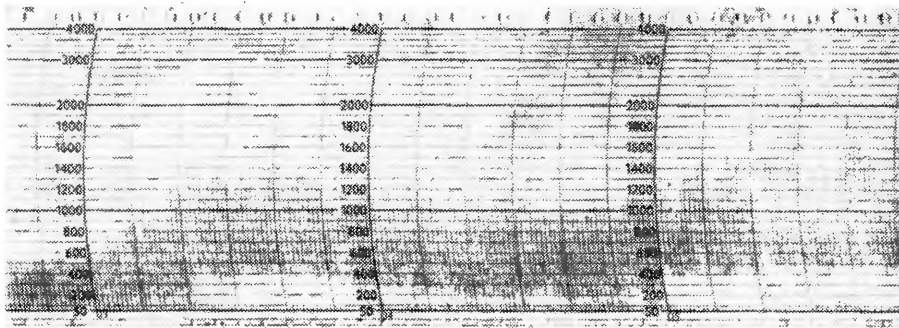

Fog lifting into low stratus.

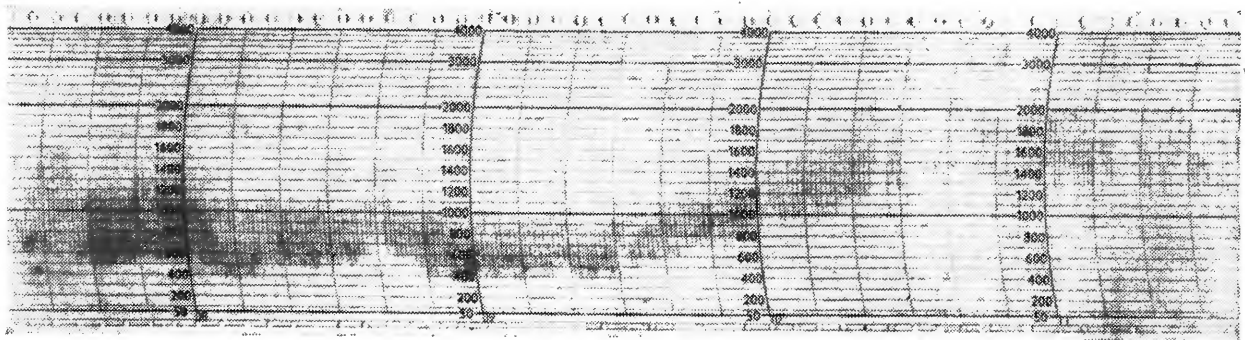

Stratus lifting and dispersing.

Typical records showing movement of cloud base.

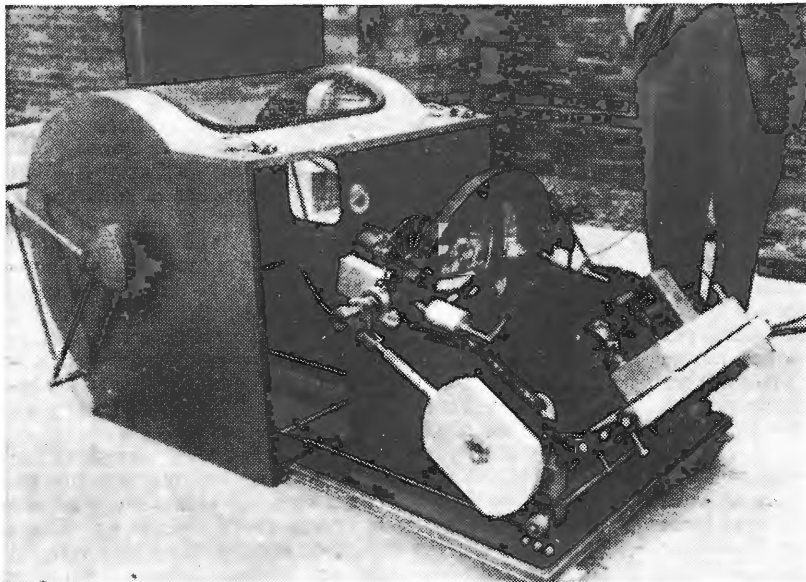

[Met. Office photo

Modulated light transmitter of automatic cloud height recorder removed from its case to show tilt mechanism.

a voltage input to a recorder thus giving a time record of bright sunshine. In the automatic station, it applies a voltage input to one of the channels of the telemetry system. This device can replace the commonly used Campbell-Stokes recorder often seen in public places at seaside holiday resorts, etc., which consist of a spherical burning glass which concentrates the sun's rays to burn a trace on a card. The card has to be changed daily.

The telemetering equipment for the automatic weather station is being built commercially and will be connected to an ordinary G.P.O. subscribers line. The cost of the hire of a private line is thus avoided. It has a self-contained answering equipment which includes a taped announcement of station identification and other relevant information. This message precedes the telemetering tones which make up the meteorological information.

At the instrument site a self-balancing multi-point potentiometer is connected in parallel with the telemetry transmitter and is used to give a continuous record of all parameters. It also records any interrogatory calls made. This continuous analogue record will be used by climatologists whereas the telemetered information will be available on demand for synoptic purposes.

Digital Loggers:—A form of recording apparatus now being introduced is a data logging equipment with a punched tape output. This equipment which is being installed at many meteorological observatories is an automatic data logger based on an electronic multi-point recorder. The twelve available inputs will normally be connected to solar and terrestrial radiation detectors in addition to the more usual transducers. As the recorder cycles round the different channels a digitizing device attached to it drives a tape punch which then produces a paper tape record amenable to machine processing to produce mean values, extremes, etc.

Radio Sondes:—Most of the equipments described above are used in comparatively small numbers but one activity in the Meteorological Office that utilizes a considerable amount of apparatus is the sounding of the upper air by

balloon-borne radio sondes. This is a small tele-metering radio transmitter which transmits data on pressure, temperature and humidity. The present radio sonde stemmed from a war-time design and is soon to be replaced by a new version which will be much easier to integrate with automatic ground receiving equipment. This ground equipment has been automated only within the last few years.

Automatic Meteorological Message Sender:—The life blood of meteorology is obviously communications and apart from facsimile, now extensively used, nothing very new in communication equipment has been introduced until recently. A new automatic message sender, which will enable teleprinter messages to be sent, at high speed, by an unskilled operator, has now been devised. The first production batch of these machines is about to be delivered by the manufacturer. When in use it is hoped that these message senders will eliminate errors in transmitted messages

which can be very troublesome, particularly when applied directly to automatic plotting and similar equipment.

Satellite Ground Station:—A satellite ground reception station is now being built at Meteorological Office Headquarters in Bracknell. It has been designed and built by the Meteorological Office and will be used to receive narrow-band facsimile pictures of cloud cover in the neighbouring area, originating from American weather satellites. This station is being constructed to receive cloud cover pictures of a different type from those of earlier weather satellites which could only transmit to certain American ground stations. An assessment of their use in routine meteorological forecasting will be made when the Bracknell station becomes operational.

This account of some of the new advanced equipment which will soon be in routine use within the Meteorological Office must, for reasons of space, ignore many specialized devices such as water vapour and ozone sondes, Doppler radar, aircraft instruments, etc., many of which, today, are finding application in research programmes as opposed to the use in day-to-day routines. It is published by permission of the Director-General of the Meteorological Office.

OUR COVER

Superimposed on a p.p.i. presentation of precipitation echoes is the double curvature scanner of the Decca Type 42A general purpose weather radar used by the Meteorological Office at a number of weather centres in the U.K. The scanner rotates at 10 r.p.m. and the 3-cm transmitter has a peak pulse power of 75kW. The display has four range scales (50, 100, 200 & 400km) and the scan can be offset. It also incorporates "interscan"—an adjustable electronic line giving range and bearing data between any two points on the display.

MATRIX ALGEBRA

1.—BASIC RULES AND SOME APPLICATIONS IN CIRCUIT ANALYSIS

By G. H. OLSEN,* B.Sc., A.M.I.E.R.E.

CONSIDERING how extremely useful this form of algebra can be in certain fields of circuit analysis, it is surprising how little attention seems to be paid to the methods involved. The use of matrix algebra has certainly not been without its ardent and expert advocates, among them Deards⁽¹⁾, "Computer"⁽²⁾, Simmonds⁽³⁾, Brown and Bennett⁽⁴⁾ and Head⁽⁵⁾; however, in several textbooks, including at least one well-known work on circuit theory, now in its second edition, it is unfortunate that authors have felt unable to include matrix methods along with other standard techniques. Of course the presentation of this technique in a textbook can give rise to some difficulties especially for authors who wish to give a comprehensive treatment. Mathematicians especially will raise their hands in horror at any exposition that does not include a rigorous groundwork; but one wonders how many of those who handle with skill and confidence such techniques as the j -notation, the D -operator, Laplace transforms and the Heaviside operator could readily explain (or understand?) the mathematical groundwork and philosophy involved. If we have a tool that makes life easier let us use it: those interested in how the tool works will soon investigate the matter further if they wish to do so.

What is matrix algebra, and how can it be used in circuit analysis? Before considering the answer to this question let us first recall some other examples where mathematics helps us to express ideas in a clear and concise manner thus enabling us to manipulate concepts more efficiently.

Perhaps the first occasion on which we come across this sort of thing is at school when, after learning the rules of a new game involving generalized arithmetic, called algebra, we learn to express verbal problems in the form of algebraic equations. Certain manipulative processes are then used to solve the equations; and thus a solution to the verbal problem is found. Later for those who wish to solve problems involving alternating currents and voltages in circuits containing resistance, capacitance and inductance we find that our mathematical equipment is inadequate. We have therefore to be taught or to invent new techniques. If the alternations are sinusoidal then, by accepting certain phase concepts, phasor diagrams (still unfortunately referred to as vector diagrams) can be useful. But, as we all know, when the circuit departs from the most elementary combinations of R , L and C the phasor diagrams are tedious or impossible to draw. The brilliant concept of Steinmetz in seeing the relationship between phasor diagrams and the mathematicians' Argand diagrams leads us to the j -notation in which the diagrams may be replaced by algebraic processes. Fortunately the rules of this algebra are very similar to those we had already learned at school except that whenever j^2 appears we write -1 . The difficulties in conceiving $\sqrt{-1}$ do not in any way detract from the usefulness of the new mathematical tool. The concept of impedance between the two

terminals of a two-terminal network has been of immense importance in the theory of a.c. networks. No matter what passive linear components combine to form the two-terminal network, we can always find a single expression for the impedance. Such an expression is in fact a single general (or complex) number of the form $R + jX$.

If the variations of voltage and current are not sinusoidal the j -notation fails us and we are forced to include the solutions of differential equations in our mathematical equipment. Differential equations can be solved in an algebraic way by employing Laplace transforms; but this is not the time to discuss this technique. However, it illustrates how, when we wish to extend our knowledge of circuit theory, it may be necessary to increase our mathematical equipment in order to cope with the new situation.

Quadripole Networks

In electronics we are frequently confronted with problems involving four-terminal networks. The algebra associated with two-terminal networks is not appropriate since the number of parameters involved is increased. It would obviously be of great value if we could find an expression, involving the minimum number of parameters, that would adequately describe a four-terminal network. Matrices are such expressions. Before such expressions can be of use to us we will need to be quite clear about what a matrix is, and to learn the rules of the game of manipulating matrices.

A matrix is a set of coefficients arranged in an orderly array of rows and columns. The number of coefficients need not be limited in a mathematical sense, but for the majority of four-terminal networks encountered in electronics we need consider only the following simple forms.

$$\begin{pmatrix} v_1 \\ i_1 \end{pmatrix} \quad \begin{pmatrix} a_{11} & a_{12} \\ a_{21} & a_{22} \end{pmatrix}$$

The first expression is known as a column matrix whilst the second is a two-by-two square matrix (i.e. having two rows and two columns). The coefficients v_1 , i_1 , a_{11} , a_{12} etc., are known as the elements of the matrix. When suitable expressions for the elements are found it is possible to describe four-terminal networks that contain linear circuit components. A suitable combination of matrices can then be found that enables us to express a set of algebraic simultaneous equations in a very concise form. Matrix algebra is the manipulation of these matrices in an orderly manner so as to obtain solutions of the equations and other useful results.

Like all unfamiliar techniques, this one will present some mechanical difficulties to the uninitiated; but with perseverance and practice it is remarkable how soon one may become an expert in circuit analysis. For

* Rutherford College of Technology, Newcastle-upon-Tyne.

those who have had to struggle in an examination with analyses that involve heavy and tedious algebraic manipulations it is hoped to demonstrate the power of the matrix method and show how this streamlined technique reduces considerably the amount of thought required.

Let us see now how we may express in matrix form the simultaneous equations that arise in the description of the following four-terminal network (see Fig. 1).

v_2 and i_2 obviously depend upon v_1, i_1 and the contents of the "black-box." One way of expressing this dependence is

$$v_1 = a_{11} v_2 - a_{12} i_2 \quad \dots \quad \dots \quad (1)$$

$$i_1 = a_{21} v_2 - a_{22} i_2 \quad \dots \quad \dots \quad (2)$$

(In general the coefficients of the first line of any equation expressed in this form are all a_1 's, the first being a_{11} , the second a_{12} , and so on. In the second line these coefficients are a_2 's with 1, 2 etc., to show position in that line.)

In matrix form this pair of simultaneous equations is expressed thus:

$$\begin{pmatrix} v_1 \\ i_1 \end{pmatrix} = \begin{pmatrix} a_{11} & a_{12} \\ a_{21} & a_{22} \end{pmatrix} \begin{pmatrix} v_2 \\ -i_2 \end{pmatrix}$$

Knowing the rules for multiplying the right-hand side the original equations can always be recovered.

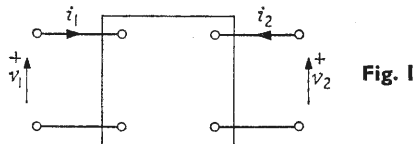

In certain cases however this is not necessary; and with practice it is possible to think in the language of matrices rather in the more familiar language of networks and algebraic equations.

Rules of the Game

Before the techniques of matrix algebra can be applied to circuit analyses it will be necessary to learn the rules governing the various manipulations. This will involve the beginner in some mental effort initially, but such effort will be well rewarded at a later stage.

The rules are:—

(1) Two matrices are equal if, and only if, they are both column or both square and the elements in corresponding positions are equal. (In spite of their appearance matrices are not determinants. The former have no "value" as have the latter.)

A column matrix can be made into a square matrix for multiplication purposes by adding noughts.

i.e. $\begin{pmatrix} a \\ b \end{pmatrix}$ may be replaced by $\begin{pmatrix} a & 0 \\ b & 0 \end{pmatrix}$

(2) Two matrices of the same kind can be added to give a third matrix as follows:—

$$\begin{pmatrix} a_{11} & a_{12} \\ a_{21} & a_{22} \end{pmatrix} + \begin{pmatrix} b_{11} & b_{12} \\ b_{21} & b_{22} \end{pmatrix} = \begin{pmatrix} a_{11}+b_{11} & a_{12}+b_{12} \\ a_{21}+b_{21} & a_{22}+b_{22} \end{pmatrix}$$

We merely add the elements in corresponding positions.

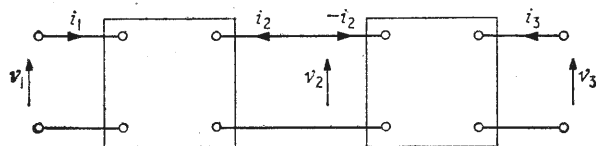

Fig. 2

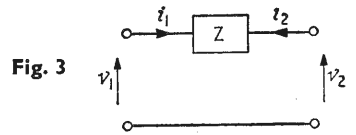

Fig. 3

(3) The multiplication of a matrix by a number merely multiplies each element by that number, i.e.

$$m \times \begin{pmatrix} a_{11} & a_{12} \\ a_{21} & a_{22} \end{pmatrix} = \begin{pmatrix} m a_{11} & m a_{12} \\ m a_{21} & m a_{22} \end{pmatrix}$$

(4) The multiplication of two square two-by-two matrices is defined in a rather complicated way; and it is this important manipulation that must be mastered. Only by sufficient practice will the user become proficient in matrix methods. Why the following system is used need not concern us here, except to note that a consistent mathematical system is defined that produces useful results.

$$\begin{pmatrix} a_{11} & a_{12} \\ a_{21} & a_{22} \end{pmatrix} \times \begin{pmatrix} b_{11} & b_{12} \\ b_{21} & b_{22} \end{pmatrix} = \begin{pmatrix} a_{11} b_{11} + a_{12} b_{21} & a_{11} b_{12} + a_{12} b_{22} \\ a_{21} b_{11} + a_{22} b_{21} & a_{21} b_{12} + a_{22} b_{22} \end{pmatrix}$$

The reader must practise this until he becomes quite familiar with the sequence of operations.

By performing the necessary multiplications we see that the commutative law does not hold in matrix algebra, i.e.

$$[A] \times [B] \neq [B] \times [A]$$

Although other rules exist these four will be sufficient for the present.

Applications

The significance of the multiplication rule becomes apparent when we consider the cascading of two four-terminal networks (Fig. 2).

$$\begin{pmatrix} v_1 \\ i_1 \end{pmatrix} = [A_1] \begin{pmatrix} v_2 \\ -i_2 \end{pmatrix} \text{ where } A_1 = \begin{pmatrix} a_{11} & a_{12} \\ a_{21} & a_{22} \end{pmatrix}, \text{ i.e.}$$

i.e., the matrix describing the first network.

However, $\begin{pmatrix} v_2 \\ -i_2 \end{pmatrix} = [A_2] \begin{pmatrix} v_3 \\ -i_3 \end{pmatrix}$

Hence $\begin{pmatrix} v_1 \\ i_1 \end{pmatrix} = [A_1] [A_2] \begin{pmatrix} v_3 \\ -i_3 \end{pmatrix}$

Therefore the combination of the two networks can be regarded as a single quadripole network that can be described by a matrix [C] such that

$$[C] = [A_1] [A_2].$$

Let us exploit this rule by first finding the matrix elements for some common circuit arrangements and then deducing the matrix for the combination of these arrangements.

From Fig. 3:—

$$v_1 = a_{11} v_2 - a_{12} i_2$$

$$i_1 = a_{21} v_2 - a_{22} i_2$$

When the output is open circuited, $i_1 = -i_2 = 0$ and $v_1 = v_2$.

$$\therefore v_1 = a_{11} v_2 \text{ i.e. } a_{11} = 1,$$

$$\text{and } 0 = a_{21} v_2 \therefore \text{ since } v_2 \neq 0, a_{21} = 0.$$

When the output is short circuited,

$$v_2 = 0, i_1 = -i_2 = \frac{v_1}{Z}.$$

$$\therefore a_{12} = Z \text{ and } a_{22} = 1.$$

Hence $\begin{pmatrix} v_1 \\ i_1 \end{pmatrix} = \begin{pmatrix} 1 & Z \\ 0 & 1 \end{pmatrix} \begin{pmatrix} v_2 \\ -i_2 \end{pmatrix}$

By similar reasoning we may build the following table (Fig. 4):

Note that from the equation $v_1 = a_{11} v_2 - a_{12} i_2$, when the output is open circuit $v_1 = a_{11} v_2$ i.e. the transfer function $v_2/v_1 = 1/a_{11}$. This is a most useful and important result.

In combining networks let us take the example of the Wien bridge circuit (Fig. 5).

Let $R_1 + \frac{1}{j\omega C_1} = Z$ and $\frac{1}{R_2} + j\omega C_2 = Y$

The matrix for the network [A] can be obtained by considering the cascading of the Z and Y portions, i.e.

$$[A] = \begin{pmatrix} 1 & Z \\ 0 & 1 \end{pmatrix} \begin{pmatrix} 1 & 0 \\ Y & 1 \end{pmatrix} = \begin{pmatrix} 1 + ZY & Z \\ Y & 1 \end{pmatrix}$$

We see immediately upon inspection that

$$\frac{v_2}{v_1} = \frac{1}{1 + ZY}$$

In fact if we were wishing to obtain only the transfer function it would not be necessary to proceed with the whole of the multiplication—obtaining the a_{11} element of [A] would suffice

Proceeding, $\frac{v_2}{v_1} = \frac{1}{1 + \left(R_1 + \frac{1}{j\omega C_1}\right) \left(\frac{1}{R_2} + j\omega C_2\right)}$

If $R_1 = R_2 = R, C_1 = C_2 = C$ the transfer function becomes

$$\frac{v_2}{v_1} = \frac{1}{1 + 1 + j\omega CR + \frac{1}{j\omega CR} + 1} = \frac{1}{3 + j\left(\omega CR - \frac{1}{\omega CR}\right)}$$

It is clear that when $\omega^2 = \frac{1}{C^2 R^2}$ i.e. $f = \frac{1}{2\pi CR}$.

v_1 and v_2 are in phase and the attenuation is $\frac{1}{3}$. These are just the results upon which to base the design of a Wien-bridge oscillator.

Many readers will no doubt be thinking that this result could have been obtained in an easier fashion using

familiar techniques; and they would, of course, be correct. The example quoted is intended to be an easy introduction to the manipulations involved. Many, however, would surely be much less confident with a three- or four-section phase-shift network for a phase-shift oscillator (Fig. 6).

In trying the ordinary Kirchoff approach to the above network, especially in an examination, a set of simultaneous

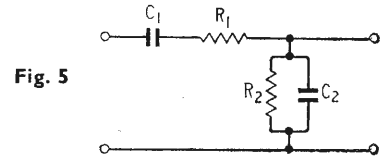

Fig. 5

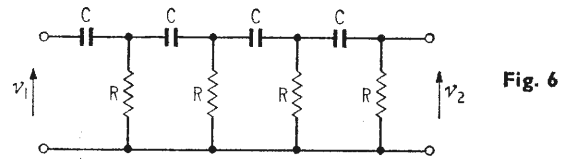

Fig. 6

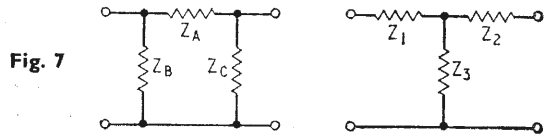

Fig. 7

equations is obtained that proves to be an algebraic handful. It is in these circumstances that the power of the matrix is revealed. The reduction in thought required to obtain a solution to the equations is very considerable.

The first CR section will have a matrix given by

$$\begin{pmatrix} 1 & Z \\ 0 & 1 \end{pmatrix} \begin{pmatrix} 1 & 0 \\ Y & 1 \end{pmatrix} \text{ where } Z = \frac{1}{j\omega C} \quad Y = \frac{1}{R}$$

$$= \begin{pmatrix} 1 + ZY & Z \\ Y & 1 \end{pmatrix} = [M]$$

The transfer function of the whole network can thus be found if the a_{11} element of the matrix of the whole network is obtained. This matrix will be $[M]^4$. Now rules exist for raising a matrix to a power, but in this case it is hardly worth while going into them.

$$[M]^2 = \begin{pmatrix} (1 + ZY)^2 + ZY & Z(1 + ZY) + Z \\ Y(1 + ZY) + Y & ZY + 1 \end{pmatrix}$$

If the transfer function is the only thing that interests us we require only the a_{11} element of $[M]^4$. This element is

$$\left((1 + ZY)^2 + ZY \right)^2 + \left(Z(1 + ZY) + Z \right) \left(Y(1 + ZY) + Y \right)$$

which on simplification yields:—

$$1 + 10ZY + 15Z^2Y^2 + 7Z^3Y^3 + Z^4Y^4$$

$$= 1 + \frac{10}{j\omega CR} - \frac{15}{\omega^2 C^2 R^2} - \frac{7}{j\omega^3 C^3 R^3} + \frac{1}{\omega^4 C^4 R^4}$$

If we combine this network with a single-stage valve amplifier having a load resistance a good deal smaller than R a four-section phase-shift oscillator results, giving an output whose frequency, f , is obtained by equating the j -term of the a_{11} element of $[M]^4$ to zero. We have $10\omega^2 C^2 R^2 = 7$ and $f = \sqrt{7}/(2\pi CR\sqrt{10})$. The value

NETWORK	MATRIX	
	$\begin{pmatrix} 1 & Z \\ 0 & 1 \end{pmatrix}$	Z IS THE IMPEDANCE BETWEEN 1 AND 2
	$\begin{pmatrix} 1 & 0 \\ Y & 1 \end{pmatrix}$	Y IS THE ADMITTANCE OF THE SHUNT ARM
	$\begin{pmatrix} n & 0 \\ 0 & \frac{1}{n} \end{pmatrix}$	IDEAL TRANSFORMER WITH TURNS RATIO n:1

Fig. 4

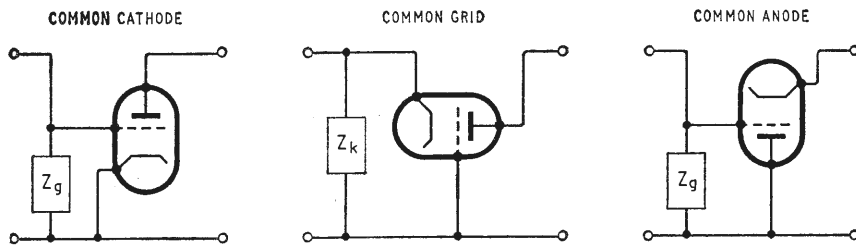

Fig. 8

$$\begin{pmatrix} -\frac{1}{\mu} & -\frac{1}{g_m} \\ -\frac{1}{\mu Z_g} & -\frac{1}{g_m Z_g} \end{pmatrix}$$

$$\begin{pmatrix} \frac{1}{1+\mu} & \frac{r_a}{1+\mu} \\ \frac{1}{Z_k(1+\mu)} & \frac{r_a + Z_k(1+\mu)}{Z_k(1+\mu)} \end{pmatrix}$$

$$\begin{pmatrix} \frac{1+\mu}{\mu} & \frac{1}{g_m} \\ \frac{1+\mu}{\mu Z_g} & \frac{1}{g_m Z_g} \end{pmatrix}$$

of a_{11} at this frequency is easily found by substitution to be -18.39 i.e. the attenuation of the network is 18.39, v_2 being 180° out of phase with v_1 .

For those keen readers who would like to try their hand, consider the Π to T and star-delta transformations (Fig. 7).

To be equivalent the corresponding elements of the matrices describing each configuration must be equal. It is then very easy to show that

$$Z_1 = Z_A Z_B / (Z_A + Z_B + Z_C)$$

$$Z_2 = Z_A Z_C / (Z_A + Z_B + Z_C)$$

$$Z_3 = Z_B Z_C / (Z_A + Z_B + Z_C)$$

Since the Π arrangement is actually the four-terminal point of view of the delta configuration and the T is the star arrangement, comparison of the same matrices give the star to delta transformation.

$$Z_A = (Z_1 Z_2 + Z_2 Z_3 + Z_3 Z_1) / Z_3$$

$$Z_B = (Z_1 Z_2 + Z_2 Z_3 + Z_3 Z_1) / Z_2$$

$$Z_C = (Z_1 Z_2 + Z_2 Z_3 + Z_3 Z_1) / Z_1$$

Valves and Transistors

Many of the networks we use are often associated with valves and transistors, consequently the appropriate matrices have been worked out for these devices. In the case of the triode, for instance, we have the following A-matrices⁽⁴⁾ (Fig. 8). (The reason for calling them A-matrices is explained later. All the matrices we have been considering so far are A-matrices.)

It will be appreciated that the circuits shown represent the a.c. equivalent, i.e. all bias and steady supply voltages are omitted, since they do not come into the signal analysis.

Consider the gain of two well-known arrangements, first the cathode-follower (Fig. 9) and then the cathode-coupled amplifier (Figs 10 and 11).

To find the gain we require the a_{11} element of the product of the two appropriate matrices.

$$\begin{pmatrix} \frac{1+\mu}{\mu} & \frac{1}{g_m} \\ \frac{1+\mu}{\mu Z_a} & \frac{1}{g_m Z_g} \end{pmatrix} \begin{pmatrix} 1 & 0 \\ \frac{1}{R_L} & 1 \end{pmatrix}$$

The a_{11} element is $\frac{1+\mu}{\mu} + \frac{1}{g_m R_L}$ and therefore the gain, A, is obtained directly.

$$A = \frac{1}{a_{11}} = \frac{\mu R_L}{r_a + R_L(1+\mu)}$$

By dividing the top and bottom by $(1+\mu)$ the configuration behaves like a conventional amplifier but having an amplification factor $\mu' = \mu / (\mu + 1)$ and an $r_a' = r_a / (1 + \mu)$. We may deduce directly that the output impedance of the cathode follower,

r_a' , is therefore $r_a / (1 + \mu) \approx r_a / \mu$ i.e. $\frac{1}{g_m}$ when $\mu \gg 1$.

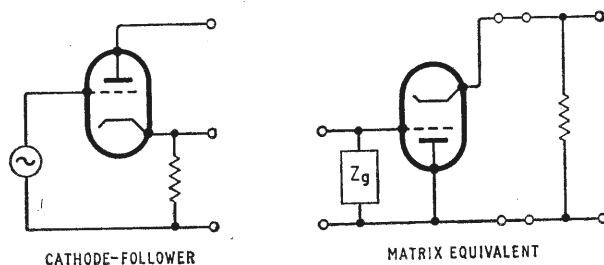

Fig. 9

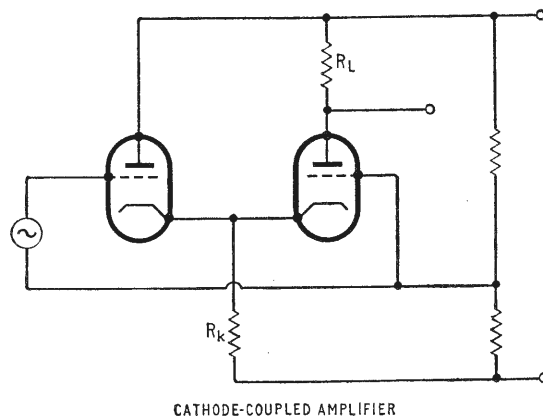

Fig. 10

The gain of the cathode-coupled amplifier can readily be obtained using matrix methods (Figs. 10 and 11). Once again the gain may be obtained by taking the reciprocal of the a_{11} element of the overall matrix. Assuming identical valves we have:—

$$\begin{pmatrix} \frac{1+\mu}{\mu} & \frac{1}{g_m} \\ \frac{1+\mu}{\mu R_g} & \frac{1}{g_m R_g} \end{pmatrix} \begin{pmatrix} \frac{1}{1+\mu} & \frac{r_a}{1+\mu} \\ \frac{1}{R_K(1+\mu)} & \frac{r_a+R_K(1+\mu)}{R_K(1+\mu)} \end{pmatrix} \begin{pmatrix} 1 & 0 \\ \frac{1}{R_L} & 1 \end{pmatrix}$$

From this it is shown in the appendix that the gain is

$$\frac{\mu R_K R_L (1+\mu)}{R_K(1+\mu)(R_L + 2r_a) + r_a(r_a + R_L)}$$

Reading the appendix may well deter the more timid members of the fraternity; but there is no doubt that they would be even more alarmed if confronted with a "conventional" analysis. Many text-books very conveniently rely on such statements that "after substituting equation (a) into equation (b)... etc. it can be shown that..." The instruction is justified on the grounds of saving paper, but the poor reader may have quite a job with some of the analyses. Matrix methods may not necessarily involve any great reduction in labour (though they often do); the advantages lie in the organization and clear procedure that is laid down.

In a short introductory account of matrix algebra many interesting and valuable aspects must be omitted. For example in obtaining transfer functions sinusoidal variations need not be the only type of waveform involved. We are quite at liberty to replace $j\omega$ with the Laplace operator p . Also it will be realized that equations (1) and (2) are not the only ones capable of describing a four-terminal network. By using other forms we may

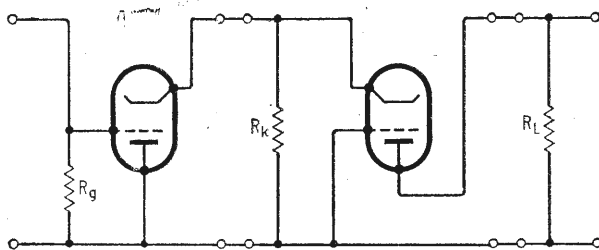

MATRIX EQUIVALENT OF CATHODE-COUPLED AMPLIFIER (Fig. 10)

Fig. 11

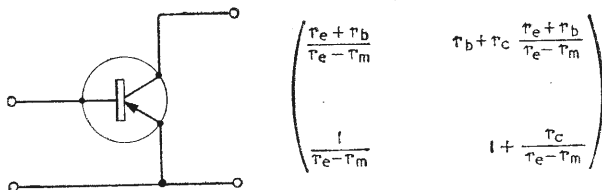

Fig. 12

obtain the impedance or Z matrices, the admittance or Y matrices and the hybrid or h-matrices. Those dealt with in this article are termed A-matrices and are useful for obtaining certain transfer functions when dealing with cascaded or chain arrangements. However, the full usefulness of matrix algebra cannot be realized until we obtain a table enabling conversion of one type of

matrix to another to be effected.* In transistor work the conversions will be found most useful, for whilst the A-matrix of the grounded emitter configuration is as shown in Fig. 12, this may not be the most convenient matrix to use. Indeed the h-matrix parameters are often considered more useful since they can be directly measured, and may be correlated with the physical action inside the transistor.

(To be concluded)

* This table will be included in the second part of this article, to be published in the April issue.

APPENDIX

$$\begin{pmatrix} \frac{1+\mu}{\mu} & \frac{1}{g_m} \\ \frac{1+\mu}{\mu R_g} & \frac{1}{g_m R_g} \end{pmatrix} \begin{pmatrix} \frac{1}{1+\mu} & \frac{r_a}{1+\mu} \\ \frac{1}{R_K(1+\mu)} & \frac{r_a+R_K(1+\mu)}{R_K(1+\mu)} \end{pmatrix} \begin{pmatrix} 1 & 0 \\ \frac{1}{R_L} & 1 \end{pmatrix}$$

$$= \begin{pmatrix} \frac{1}{\mu} + \frac{1}{g_m R_K(1+\mu)} & \frac{1}{g_m} + \frac{r_a+R_K(1+\mu)}{g_m R_K(1+\mu)} \\ \frac{1}{\mu R_g} + \frac{1}{g_m R_g R_K(1+\mu)} & \frac{1}{g_m R_g} + \frac{r_a+R_K(1+\mu)}{g_m R_g R_K(1+\mu)} \end{pmatrix} \begin{pmatrix} 1 & 0 \\ \frac{1}{R_L} & 1 \end{pmatrix}$$

The a_{11} element for the product is:—

$$\frac{1}{\mu} + \frac{1}{g_m R_K(1+\mu)} + \frac{1}{R_L g_m} + \frac{r_a+R_K(1+\mu)}{R_L g_m R_K(1+\mu)}$$

$$= \frac{R_K R_L (1+\mu) + r_a R_L + r_a R_K (1+\mu) + r_a (r_a + R_K (1+\mu))}{\mu R_K R_L (1+\mu)}$$

$$= \frac{R_K (1+\mu) (R_L + 2r_a) + r_a (r_a + R_L)}{\mu R_K R_L (1+\mu)}$$

Hence the gain is given by:—

$$\frac{\mu R_K R_L (1+\mu)}{R_K (1+\mu) (R_L + 2r_a) + r_a (r_a + R_L)}$$

REFERENCES

- (1) Deards, S. R., "Matric Theory Applied to Thermionic Valve Circuits," *Electronic Engineering*, Vol. 24, June, 1952, pp. 264-7.
- (2) "Computer," "Matrices—1, General Principles," *Electronic and Radio Engineer*, Vol. 35, No. 2, Feb., 1958, p. 67; and later articles in March and April, 1958, Jan., 1961.
- (3) Simmonds, J. C., "Matrix Algebra," *Electronic Engineering*, Vol. 16, p. 160 (1943).
- (4) Brown, J. S., and Bennett, F. D., "Application of Matrices to Vacuum-Tube Circuits," *Proc. I.R.E.*, Vol. 36, p. 844, July, 1948.
- (5) Head, J. W., and Colebrook, F. M., "Basic Mathematics for Radio and Electronics," Iliffe and Sons Ltd. (1957).

APRIL ISSUE

A preview of the London Audio Festival and Fair (April 22nd-25th) will be included in the April issue of *Wireless World* which will be published on March 29th. In addition to the preview, in which the equipment to be shown by each of the 85 exhibitors will be summarized, there will be articles of special interest to the audiophile as well as the usual quota of regular features.

Transistor Wide-band Cascade Amplifiers

By F. BUTLER, O.B.E., B.Sc., M.I.E.E., M.I.E.R.E.

THIS paper is concerned with the properties of three types of amplifier in which the active elements, valves or transistors, are connected in series with respect to the amplified signal current. It does not follow that these elements are necessarily in series with respect to the d.c. power supplies though this circumstance makes no difference to the basic theory. The best-known example of a series-connected amplifier is probably the cascode. Another is the White cathode follower while a third is a special bootstrap arrangement of two valves. All three have been in use for a long time but people keep re-inventing at least two of them so that they are evidently not as well known as they ought to be. The linear theory of the valve versions has been competently set out in a number of papers and it is known that transistor counterparts have been used in several items of equipment though only the cascode circuit appears to have been fully written up¹ in a technical journal. Even this account is not readily accessible to the general reader.

Analysis of the valve circuits presents no particular difficulty and it is easy to derive expressions for the voltage gain and the output impedance. By contrast, the transistor analysis is very tedious and, unless gross simplifications are made, the final expressions are cumbersome and do not easily lead to a successful design. Although the procedure is repugnant to some people it is much easier to optimize the choice of components for a transistor amplifier by experimental methods, using valve theory as a guide to the order of magnitude of the quantities involved. In a multistage d.c. coupled amplifier it is safe to say that some empirical checks and modifications must be made, no matter how precise the initial analysis may be.

Cascode Valve Amplifier

The basic cascode circuit, shorn of bias, coupling and decoupling details, is given in Fig. 1, which also shows the symbols used in the analysis.

On replacing the actual valves by their equivalent generators it can be shown that the voltage gain is given by:

$$A = \frac{E}{e} = - \frac{\mu R}{r_1 + \frac{r_2 + R}{\mu_2 + 1}} \quad \dots \quad (1)$$

The negative sign indicates a phase reversal. The limiting gain in a number of special cases is of interest. If $R \ll r_1$ or r_2 then, ignoring the sign, the gain is $g_1 R$. It is the gain of the lower valve of the pair with a small load resistance R and is independent of the characteristics of the upper valve. If $R \gg r_1$ or r_2 the gain becomes $A \approx \mu_1 \mu_2$ as for any other 2-stage amplifier with infinite load resistances.

The output impedance R_0 is given by:

$$\frac{1}{R_0} = \frac{1}{R} + \frac{1}{(\mu_2 + 1)r_1 + r_2} \quad \dots \quad (2)$$

With normal valves and load resistances, R_0 is practically equal to R . The output impedance of the cascode circuit alone is obtained by setting $R = \infty$ and is $(\mu_2 + 1)r_1 + r_2$. Clearly this is very large indeed, approaching or exceeding the impedance of a pentode or tetrode valve. This is the virtue of the cascode. It has the gain of a pentode with the low noise of a triode. It is a close approximation to a constant-current source.

As a video amplifier, a useful combination employs a cascode to drive a cathode follower. D.c. coupling may be used between the stages so that the response extends down to zero frequency. The overall voltage gain is the product of the gain of the cascode and that of the cathode follower. The output impedance is that of the cathode follower alone. Because of the inherent feedback in both stages, distortion is low and wide-band amplification is easy to achieve.

The White Cathode Follower

The essentials of this circuit are shown in Fig. 2. The voltage gain and output impedance are given by the expressions:

$$A = \frac{\mu_1}{\mu_1 + 1} \cdot \frac{R_L}{R_L + \frac{(r_1 + R)(r_2 + R_L)}{(\mu_1 + 1)(r_2 + \mu_2 R)}} \quad \dots \quad (3)$$

$$R_0 = \frac{r_2}{1 + \frac{(\mu_1 + 1)(r_2 + \mu_2 R)}{r_1 + R}} \quad \dots \quad (4)$$

With reasonable component values the gain is close to unity and the output impedance is very low indeed. If R is very large, R_0 is almost equal to $1/\mu_1 g_2$. If $\mu_1 = 80$ and $g_2 = 10 \text{ mA/V}$, $R_0 = 1.25 \text{ ohms}$.

The basic circuit is deceptively simple in appearance but it becomes much more complex when bias, coupling and decoupling components are added. It will be seen later that the transistor version is more attractive in this respect.

The Series Bootstrap Circuit

This arrangement is shown in Fig. 3. Its voltage gain is:

$$A = \frac{E}{e} = - \frac{\mu_1 R_L (r_2 + \mu_2 R)}{(r_1 + R)r_2 + (r_1 + r_2 + (\mu_2 + 1)R)R_L} \quad (5)$$

Regardless of the choice of component values, the limiting gain is always less than μ_1 .

The output impedance is:

$$R_0 = \frac{r_2 (r_1 + R)}{r_1 + r_2 + (\mu_2 + 1)R} \quad \dots \quad (6)$$

In the limit, as $R_1 \rightarrow \infty$ and with $\mu_2 \gg 1$, $R_0 = 1/g_2$. This is the output impedance of the upper valve, regarded as a cathode follower.

One feature of this circuit is the ease with which feedback may be applied to an earlier stage so as to cause a

further reduction of output impedance and an increase of the input impedance of the pre-amplifier stage. The second point is perhaps of more importance in transistor amplifiers than in valve versions in which the input impedance is already high enough for most purposes.

Variants of the Cascode

As a tuned r.f. amplifier the cascode in its basic form is a useful circuit. As a wide-band amplifier it is better still if used, as already mentioned, to drive a cathode follower. If μ_3 and r_3 are respectively the amplification factor and the anode slope resistance of the cathode follower valve, the overall voltage gain is:

$$A = \frac{\mu_1(\mu_2 + 1)R}{\left(1 + \frac{r_3 + R_L}{\mu_3 R_L}\right) [(\mu_2 + 1)r_1 + r_2 + R]} \quad (7)$$

The output impedance is:

$$R_0 = \frac{r_3}{\mu_3 + 1} \approx \frac{1}{g_3} \quad \dots \quad (8)$$

In equation (7), R is the anode load of the cascode pair and R_L the load of the cathode follower. Equation (8) gives the output impedance looking into the cathode terminal of the output stage, ignoring R_L itself. If R_L is the d.c. load resistance and if another load is capaci-

tively coupled to it, the effective output impedance, seen from the terminals of the external load, is of course R_0 in parallel with R_L .

Fig. 4 is another circuit which at first sight looks promising but which, on closer investigation, turns out to be rather disappointing. It can be described as a cascode driving a bootstrap follower.

Its voltage gain is:

$$A = \frac{\mu_1(\mu_2 + 1)R}{\mu_2 R + \left(1 + \frac{r_3 + R_L}{\mu_3 R_L}\right) [(\mu_2 + 1)r_1 + r_2 + R]} \quad (9)$$

This expression differs from equation (7) by the inclusion of the term $\mu_2 R$ in the denominator, causing reduced gain. The output resistance is:

$$R_0 = \frac{r_3}{\mu_3 + 1 + \frac{\mu_2 \mu_3 R}{(\mu_2 + 1)r_1 + r_2 + R}} \quad \dots \quad (10)$$

If μ_1 , μ_2 and μ_3 are all $\gg 1$ and if r_1 , r_2 and r_3 are all of the same order of magnitude as R, the output impedance is given approximately by the expression

$$R_0 \approx \frac{1}{g_3} \cdot \frac{r_1}{r_1 + R}$$

Although R_0 is less than for a normal cathode follower, it depends on the source resistance presented by

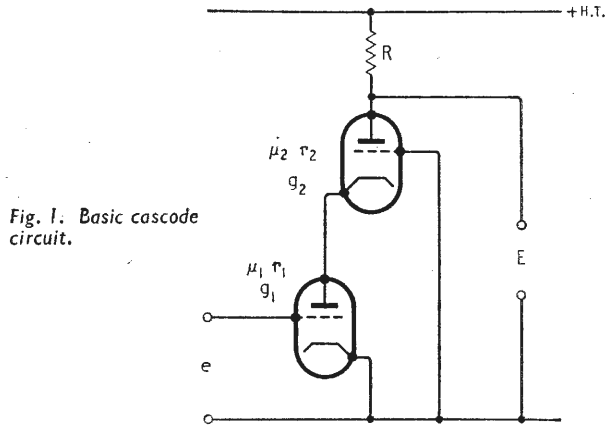

Fig. 1. Basic cascode circuit.

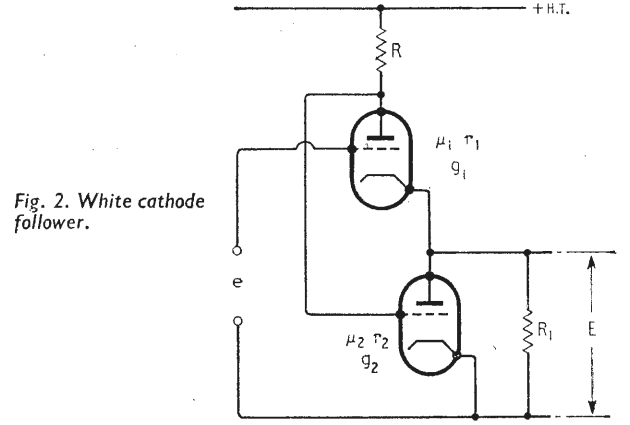

Fig. 2. White cathode follower.

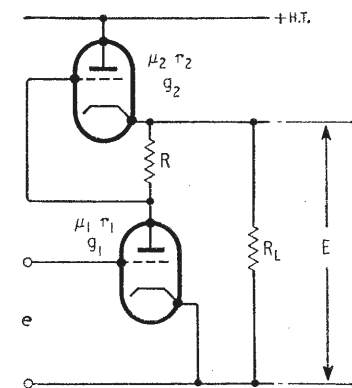

Fig. 3. Series bootstrap amplifier.

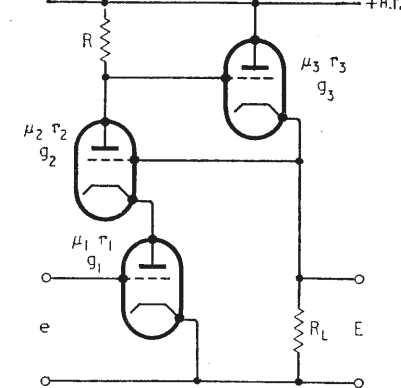

Fig. 4. Cascode driving a bootstrap follower.

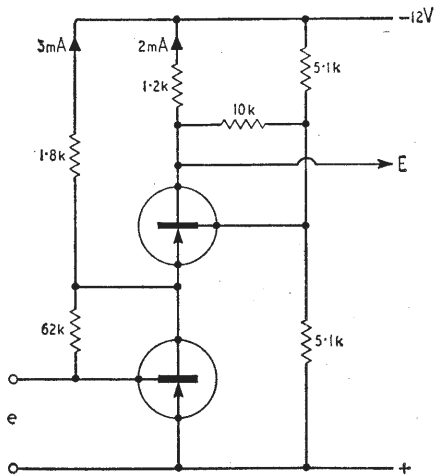

Fig. 5. Cascode video amplifier (V. Zavrzhnov and G. Kryukov).

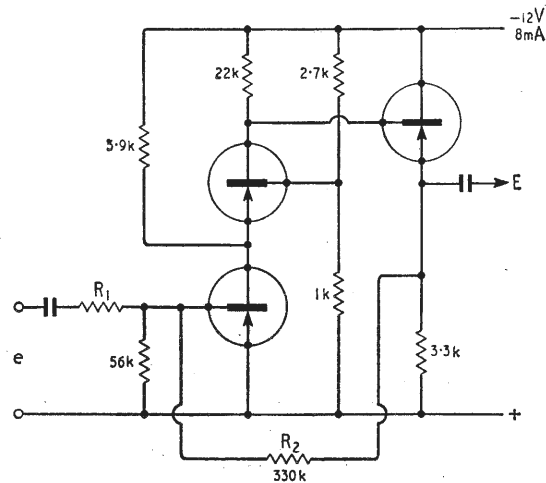

Fig. 6. Feedback cascode with emitter follower.

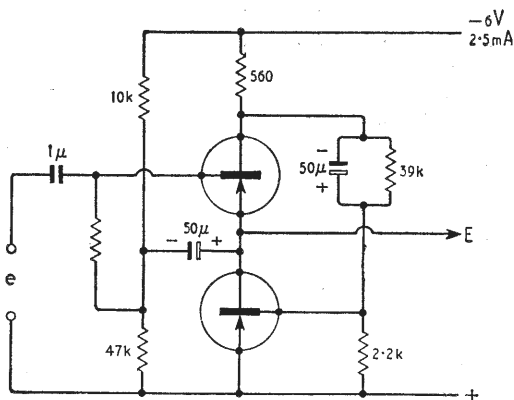

Fig. 7. Bootstrapped White emitter follower.

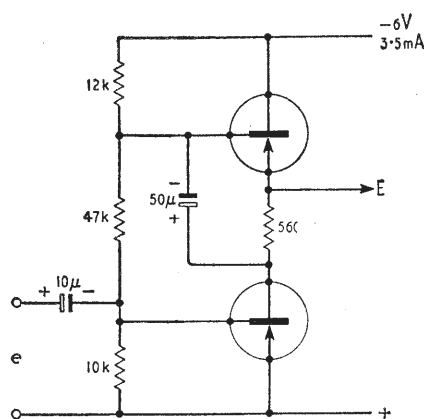

Fig. 8. Bootstrapped cascode pair.

the driver stage. Moreover, the reduced output impedance is achieved at the expense of a disproportionate reduction of gain.

Transistor Cascode and Derivatives

The valve circuits just described have characteristics which are of value in a number of different applications but these useful features are offset by some practical disadvantages. The direct series connection of thermionic valves is inconvenient because of the high voltages required and also because of difficulties with heater-cathode insulation, hum pick-up and related problems. Transistor circuits are much more attractive, especially if one is prepared to make use of complementary types. Direct coupling becomes feasible in multistage amplifiers, saving components, extending the frequency range down to d.c. and improving the phase characteristics at high frequencies while permitting the stabilization of the operating points of the active elements by overall d.c. feedback.

A preferred method of preventing interaction between cascaded transistor amplifiers is to design for a gross mismatch of impedances in the interstage couplings. For example, a stage with a high output impedance may be used to drive one with a low input impedance. This accounts for the fact that a transistor cascode tuned r.f. amplifier may sometimes be used without neutralization or unilateralization. For the same reason a cascode pair makes a good video amplifier. Fig. 5 shows one possible arrangement; (reference 1).

With the component values shown the response is flat from 0 to 6 Mc/s. Higher gain at the cost of reduced bandwidth can be achieved by changing the 1.2 kΩ collector load to 12 kΩ or 22 kΩ, removing the 10 kΩ feedback resistor and reducing the base-bias elements from 5.1 kΩ to 1.2 kΩ each. The lower transistor is operated with a larger collector current than the upper element.

Fig. 6 is a virtual-earth feedback amplifier giving a voltage gain $A \approx R_2/R_1$. Its output impedance is almost zero, the input impedance is practically R_1 ,

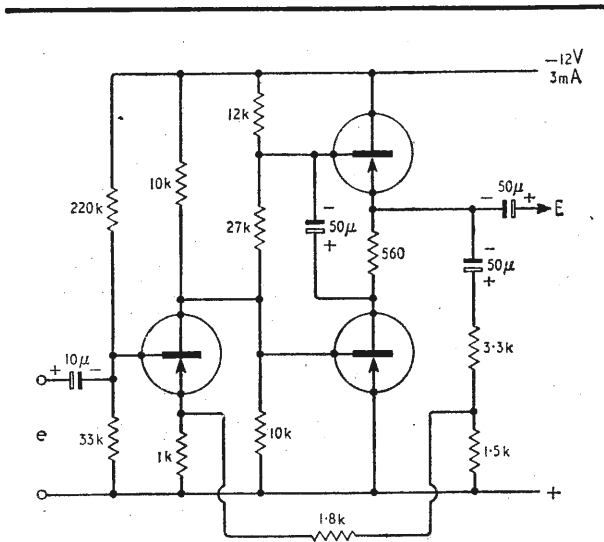

Fig. 9. Feedback amplifier developed from Fig. 8.

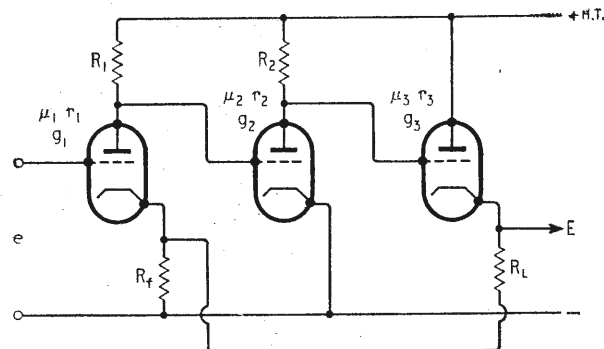

Fig. 10. Ring-of-three valve amplifier.

(more accurately $R_1 + 250 \Omega$). With $R_1 = 0$, the voltage gain is around 300. Except for the input and output capacitors, d.c. coupling and feedback are used, saving components and giving an improved performance.

White Emitter Follower

Fig. 7 shows this circuit in a bootstrapped form, arranged to give a very high input impedance. It can be converted to the normal form by removing the capacitor connected between the bias network and the junction of the transistors. With the component values shown the input impedance is $0.5 \text{ M}\Omega$, the voltage gain is almost unity and the output impedance is virtually zero. The maximum undistorted output is 1.2V r.m.s. from a 6V supply or 3V r.m.s. from a 12V source.

The circuit is useful as it stands. It is still more attractive if driven from a d.c. coupled common-emitter stage or from a cascode such as that shown in Fig. 6. If the bootstrapping is removed the complete amplifier is simple and economical in components.

Bootstrapped Cascade Pair

This arrangement is shown in Fig. 8, with representative component values. The input impedance is 1200Ω , the output impedance around 50Ω and the voltage gain between 100 and 200, depending on the choice of transistors. The amplifier gives a phase-reversed output.

Finally, Fig. 9 shows a feedback amplifier developed from Fig. 8. The input impedance is about $30 \text{ k}\Omega$, the voltage gain is 340 without feedback, reduced to 10 by feedback. The frequency response, using cheap h.f. alloy junction transistors, extends to 1200 kc/s and the maximum output is 2.5 V r.m.s.

Equalization

One factor which has to be taken into account in designing a wideband amplifier is the question of equalization of the gain and control of the phase shift. In a simple feedback amplifier, top lift or cut can be tailored to the specification by shunt capacitance across one or other of the feedback resistances. It may sometimes be necessary to make use of bridged-T equalizers or R-C lag-lead networks to get the required response with stability. Any of these schemes may be applied to the simple amplifiers shown in Figs. 6 and 9. In these and in the other transistor circuits, using Ediswan-Mazda h.f. alloy junction transistors, Type XA102, it is easy to achieve a bandwidth in excess of 1 Mc/s and up to 3.5 Mc/s is attainable by sacrificing gain. The transistors described are available cheaply on the surplus market. By using silicon planar epitaxial transistors with a transition frequency around 300 Mc/s it is possible to get a response flat to 8 Mc/s or up to 20 Mc/s with reduced gain.

Conclusion

It has been shown that series-connected pairs of transistors make useful and economical wide-band amplifiers. The gain, bandwidth, input impedance and output impedance of one or other of the various types can be made to meet requirements. Direct coupling is feasible and a large output voltage is available using relatively low supply voltages. The technique of mismatching impedances in the interstage couplings of a multistage amplifier may be used to reduce interaction between stages. Nevertheless, it is only fair to point out that a similar, and in some cases an improved performance, can be given by other amplifier configurations. As a general rule, local feedback over one or two stages of an amplifier is of questionable value and it is more economical to use feedback over at least three stages, even though extra care may be required to maintain stability.

When a video-type amplifier is required to have a high input impedance, a low output impedance, low distortion, moderate gain and large bandwidth it is doubtful if one could do better than choose the well-known ring-of-three circuit. The valve version is shown in basic form in Fig. 10.

With no feedback ($R_f = 0$), the voltage gain is:

$$A = \frac{\mu_1 R_1}{R_1 + r_1} \cdot \frac{\mu_2 R_2}{R_2 + r_2} \cdot \frac{\mu_3 R_3}{(\mu_3 + 1) R_L + r_3} \dots \quad (11)$$

The output impedance is:

$$R_0 = \frac{r_3}{\mu_3 + 1} \text{ or } \frac{r_3}{\mu_3 + 1 + \frac{R_L}{r_3}} \dots \quad (12)$$

There are two alternative expressions for the output impedance, depending on whether or not R_L is included,

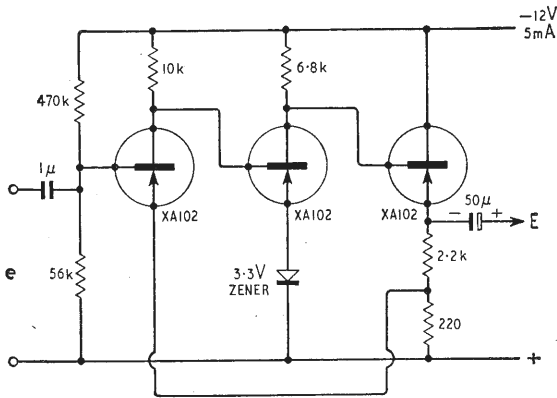

Fig. 11. Ring-of-three transistor amplifier.

If A is very large, the gain is:

$$m = \frac{R_L + R_f}{R_f} = 1 + \frac{R_L}{R_f} \dots \dots \dots (14)$$

The output impedance, with feedback, is given approximately by:

$$R_0 = \frac{1 + \frac{R_L}{R_f}}{g_3 A} = \frac{m}{g_3 A} \dots \dots \dots (15)$$

With heavy feedback, R_0 is obviously very small indeed.

The transistor ring-of-three arrangement is shown in Fig. 11. To allow d.c. coupling between the first and second transistors a 3.3V Zener diode is connected in the emitter lead of the second transistor. The amplifier has an input impedance of about 50 kΩ, a voltage gain of 15 and the output impedance is almost zero. Without special equalization, the bandwidth is 3.5 Mc/s. Apart from the input and output capacitors, the amplifier lends itself to microminiaturization and it is surprising that no manufacturer has seen fit to produce a range of analogue circuits of this type to match the digital units which are fairly readily available. Such circuits would be extremely useful as building blocks in measuring equipment, oscilloscope pre-amplifiers, television studio equipment², as video amplifiers and also in analogue computers and data-processing equipment.

REFERENCES

1. V. Zavrazhnov and G. Kryukov, "Wide Band Transistor Amplifier," *Telecommunications* (a Soviet journal) No. 10, October, 1961, p. 41.
2. D. Bray and G. E. Hayden-Pigg "Video Circuits for Transistor Television Cameras," *Journ. S.M.P.T.E.*, Vol. 72, No. 11, November 1963, p. 853.

as would be necessary if the true external load were capacitively coupled to the output stage.

With feedback, the voltage gain is given by:

$$m = \frac{E}{e} = \frac{1}{\frac{1}{A} + \frac{R_f}{R_L + R_f}} \dots \dots \dots (13)$$

H. F. PREDICTIONS — MARCH

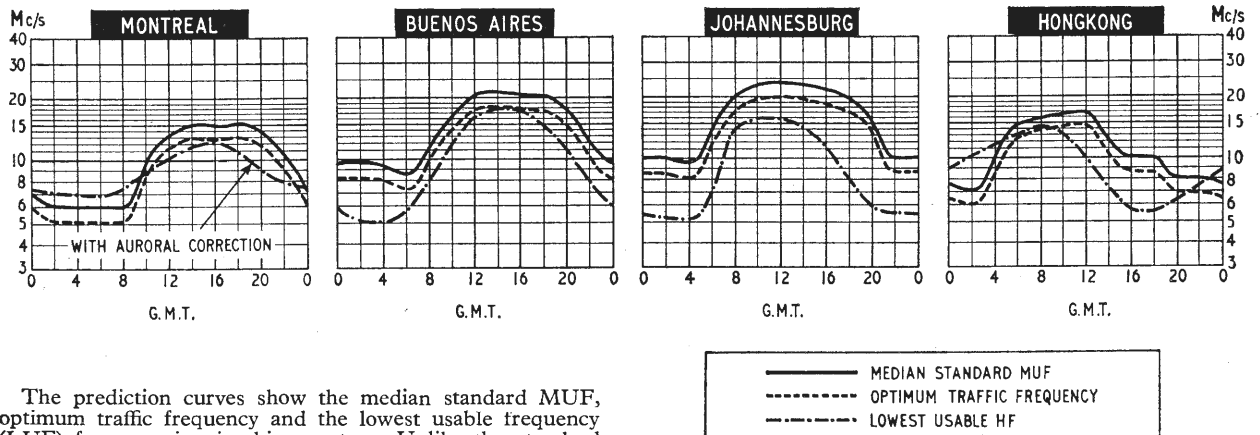

The prediction curves show the median standard MUF, optimum traffic frequency and the lowest usable frequency (LUF) for reception in this country. Unlike the standard MUF, the LUF is closely dependent upon such factors as transmitter power, aerials, and the type of modulation. The LUF curves shown are those drawn by Cable and Wireless Ltd. for commercial radiotelegraphy and assume the use of transmitter power of several kilowatts and rhombic type aerials.

As stated last month, it seems likely that the sunspot minimum has passed, and steady increase in the value of the sunspot number would be expected over the next few years.

Some details of the sunspot cycles, which has a period of approximately 11 years, are known from the year 1610 onwards, although detailed monthly figures are only known from 1750 onwards. The Zürich sunspot number, also called the Wolf sunspot number, is defined as: $k(f+10g)$, where g is the number of sunspot groups and f is the number of spots within these groups. The factor k allows for the variations between telescopes and observers.

RECENT TECHNICAL DEVELOPMENTS

Hydrogen Maser Clock

Two of Varian Associates atomic hydrogen maser clocks, claimed to be the world's most accurate, have been delivered to NASA for evaluation in space experiments, which include satellite tracking and tests on Einstein's predictions on the effect of gravity on time.

In the maser hydrogen atoms are separated into two hyperfine states by a magnetic field and the higher energy state is directed into a quartz bulb in a cavity resonator. The bulb is coated with a material (such as p.t.f.e.) to avoid disturbance of the energy state of an atom on impact, which results in the relatively long time necessary to achieve the sharp line. The radiation emitted when the atoms fall to the lower energy level maintains oscillations at the hydrogen frequency of 1,420, 405, 751.732 c/s.

The wall coating has been known to produce perturbations in frequency of 1 part in 10^{11} but Varian state that monthly stability is better than 5 parts in 10^{13} .

Improving Recording Density

There are several methods of improving information recording density, or high-frequency response, of magnetic tape recorders but most are dependent on the manufacturer. An obvious means would seem to be to reduce the recording head gap width. If this is to be done without reduction of the magnetic layer thickness, the gap field must be increased in order to bias the outermost region of the layer, and this results

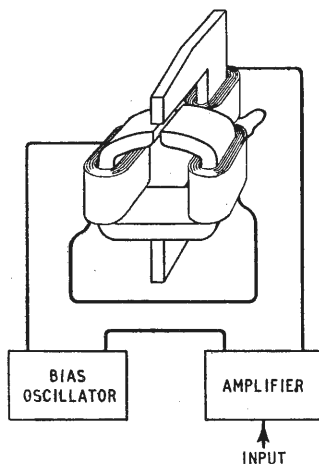

Fig. 1. Cross-field head.

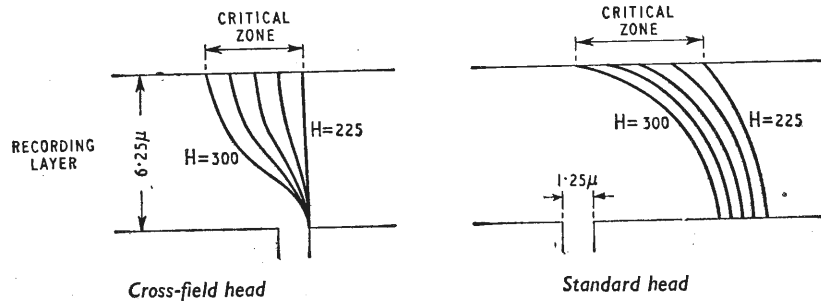

Fig. 2. Micro-gap head critical zones.

in a critical (recording) zone of much the same size as before. (The critical zone, and therefore recording resolution, is directly proportioned to the thickness of the recording layer.)

One method is to produce a sharper field gradient and consequently shorter critical zone. This may be done by adding a vertical field, the resultant field being more intense on one side of the gap and having a sharper gradient on the other side. (This may be seen by vector addition of the fields.) Such a cross-field head was described in *Journ. SMPTE* Vol. 58, January, 1952, by M. Camras. (See Fig. 1.) This head is somewhat inconvenient due to the pole pieces on either side of the tape and a head has been developed with the pole pieces on the same side of the tape.

A micro-gap head is briefly described in *IEEE Transactions on Audio* Vol. 12, No. 3, May-June, 1964, by the same author. Critical zones are shown

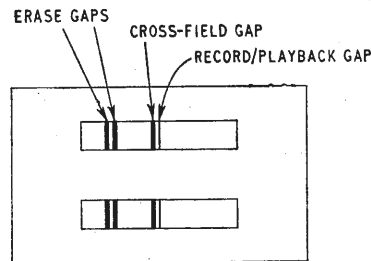

Fig. 3. Stereo cross-field head.

(Fig. 2) for a gap width of 1.25 microns using a cross-field head (gap field 750 oersteds) and a standard head (gap field 4700 oersteds). A cross-field micro-gap head is illustrated in Fig. 3, which con-

tains two identical heads for quarter-track stereo. A two-gap erase section precedes the cross-field gap which is energized by the erase winding. Elimination of a separate erase head compensates for the cost of the additional cross-field structure, making the overall cost comparable to conventional heads.

Miniature Electron Multiplier

A miniature electron multiplier has been developed by Mullard Research Laboratories for use in space research. The device has a power consumption of $200 \mu\text{W}$, and thus is ideally suited for application in satellites.

The multiplier consists of a glass tube 1 mm in diameter open at one end and coated inside with a high resistance material. Unlike a conventional multiplier the coating acts as a continuous dynode, so that with a single potential of 1 kV-5 kV across the tube and exposure to ionizing radiations, the coating emits electrons at the mouth of the tube, which then avalanche towards the closed end of the tube, according to the normal process of secondary emission and electron multiplication. The gain of the device is about 10^8 times the 5 kV across the tube, and may have a useful gain at voltages much less than this. (The gain at 2.5 kV is 10^5 .)

The tube is sensitive to electrons and gas ions with energies of up to 20 keV and possibly higher and electromagnetic radiation in the far ultraviolet and soft X-ray region. With a gold layer deposited at the tube mouth the usable wavelength can be increased to $2,500 \text{ \AA}$. The gain of the device is dependent on the ambient gas pressure but if the tube is helical (say with a diameter of 8 mm) the gain becomes relatively independent of pressure within certain limits.

THE COLOUR SITUATION

THREE SYSTEMS LINE UP FOR BATTLE AT VIENNA

AT the end of March, members of the International Radio Consultative Committee (C.C.I.R.) will be meeting in Vienna to try to decide which colour television system—N.T.S.C., SECAM or PAL*—should be adopted as a standard for Europe. These members will be official representatives of the governments of the countries concerned. If they cannot reach a unanimous decision, which seems only too likely, the choice could be made by a majority vote. Ostensibly the decision will be made on a rational technical basis, but in fact it is more likely to be determined politically by the interests of the various member countries. The most powerful faction will no doubt win. Even then the decision made in Vienna may not be accepted by the individual countries concerned, who may all go ahead independently with the systems of their own choice.

The Vienna debate will, in fact, be the culmination of a long series of technical meetings on colour television standards which have stretched over almost a decade. They have been held not only by the C.C.I.R. (in particular by its Study Group XI on television) but also by the European Broadcasting Union and its opposite number in Eastern Europe, the International Radio and Television Organization (O.I.R.T.). The E.B.U. formed an *ad hoc* committee for colour television in 1962, and the most recent meeting was one held in Paris in January in which this E.B.U. committee, together with a group from O.I.R.T., attempted to clarify the technical issues for the benefit of the countries which would be attending at Vienna. The discussion did not, however, produce any definite conclusions.

National Attitudes

Principal supporters of the N.T.S.C. system are the U.K. and Holland. SECAM is strongly backed by France and PAL by West Germany—the countries in which these respective systems originated. The attitudes of other countries taking part are as yet uncertain although it is believed that Italy favours PAL. The U.S.S.R. is considered to be a major influence in the political tug-of-war as she will probably bring all the East European countries with her—amounting to about 50% of the voting power. It was reported that the Russians were particularly impressed with SECAM because the colour information appeared to be less susceptible to distortion when transmitted over long-distance links than in other systems—an important consideration in a country as large as the U.S.S.R. The arrival on the scene of the British corrector for differential phase and gain distortions in the N.T.S.C. signal†, however, appears to have redressed this apparent advantage of SECAM. It has been pointed out by the advocates of PAL that the British corrector, excellent as is its performance, compensates only for distortions in the equipment and cannot overcome distortions (e.g. multi-path) in the medium. It is claimed that PAL, which

depends on the accommodation of the eye in averaging distortions from all causes, is therefore a superior system.

The Russians' present lively interest in colour television systems arises largely from their wish to have a colour broadcasting service in operation in time for the 50th anniversary celebrations of the 1917 Bolshevik Revolution.

Apart from the official views of the respective countries, there are, of course, a number of commercial interests involved, and the principal companies concerned with colour television have been issuing a good deal of propaganda designed to influence the discussions at Vienna in their own favour. The N.T.S.C. system is backed by European subsidiary companies of the Radio Corporation of America (R.C.A.) which played a major part in devising the system. SECAM is promoted by its French originators, the Compagnie Française de Télévision (formed by CSF and Saint Gobain, the glass manufacturers), while PAL has behind it the resources of the German company who developed it, Telefunken.

Moscow Broadcasts

Demonstrations have played an important part in this commercial propaganda. R.C.A. Great Britain, for example, have been touring Northern Europe with a mobile colour television unit. At the end of January they gave N.T.S.C. colour demonstrations in Moscow. Cameras were installed in Moscow's television centre, and four 1½-hour programmes were broadcast on the city's Channel 8. The programmes were viewed on Rank-Bush-Murphy and R.C.A. receivers set up within a 20-mile radius of the transmitter. During the programmes the N.T.S.C. signals were experimentally switched from time to time through a 6,000-km television distribution link before transmission so that the effect of long-distance hook-ups on the signal could be seen on the receivers. The B.B.C. correction equipment already referred to was used to correct differential phase and gain distortions introduced by the link. Earlier C.F.T. had demonstrated SECAM in Moscow, and comparative tests between N.T.S.C. and SECAM had been arranged by engineers of the Russian State Committee on Radio-electronics with help from Britain and France. Programme material in colour was provided by a Rank Cintel slide scanner, and encoders to give N.T.S.C. and SECAM signals were made available by the B.B.C. and C.F.T. respectively.

Later the R.C.A. mobile unit moved on to Paris where demonstrations were given in February at the laboratories of the French national broadcasting authority, O.R.T.F. After Paris the mobile unit moves on to Frankfurt, Nuremberg, Zagreb, Milan and Vienna.

Also in February Telefunken demonstrated the PAL system in Berlin to representatives of the international technical press. As an indication of their wish that this system should be judged solely on its technical merit, the company stated that any royalties (relating primarily to the delay line in the receiver) would not add more than 0.5% to the factory cost of the receiver. Initially the delay line itself would cost about 20 DM (£2), and the total extra cost of a PAL receiver might be 4% but

*For brief technical descriptions and performance comparisons of the three systems, see "Colour Television Systems," *Wireless World*, September, 1963.

†See "Correcting Colour Signal Distortion," this issue, p. 113.

it was expected that in the third year of a regular colour television service, production would be running at a level high enough to bring the price of a PAL receiver down to that of an N.T.S.C. receiver.

In Britain the Postmaster General has reaffirmed the U.K.'s support of N.T.S.C., in the light of earlier reports suggesting that Britain could be swayed towards either of the other two systems. Replying to a question in the House of Commons, he said that a former criticism that the N.T.S.C. system was unsuitable for transmitting over long distances had been shown to be unfounded.

Further British support for N.T.S.C. has come from the British set manufacturers in the shape of a report from B.R.E.M.A. setting out the reasons for their preference for this system. Their approach to the subject has been to ask themselves (1) whether the N.T.S.C. system will give satisfactory pictures on easily manufactured domestic receivers operated by unskilled people and (2) whether any other system will give results sufficiently better to justify a departure from N.T.S.C.

To help to answer the first question B.R.E.M.A. have conducted a series of home-viewing tests on British made colour receivers with the object of assessing the controllability and picture quality of these sets. Forty receivers were used and results were obtained from 127 different homes in which they were installed. The programmes were varied material transmitted by the B.B.C. from Crystal Palace on Channel 33, and the viewing sessions lasted for about one hour. One test provided information on the frequency with which the tuning, saturation and hue controls of the receiver had to be adjusted. With the tuning control, 73% of the viewing sessions required no adjustment at all, 21% resulted in one adjustment and the remaining 6% needed two or three adjustments. With the saturation control, 44% of the sessions called for no adjustment, 29% needed one adjustment, and 27% required two or three adjustments. With the hue control, 45% of the sessions needed no adjustment, 30% called for one adjustment and 25% required two or more adjustments. Of all the adjustments made, 48% occurred at the start of the session and 28% resulted from a change of programme material.

As for ease of adjustment, the subjective mean rating for all three controls fell between "very easy" and "easy" on a six-grade scale extending from "very easy" to "very difficult."

The subjective tests for colour picture quality, based on 1,149 replies representing some 1,600 man-hours of viewing, gave a mean rating which fell between "excellent" and "good" on a six-grade scale ranging from "excellent" to "very poor." Compatibility was investigated by assessing the impairment of the monochrome picture resulting from a colour transmission. Here the mean rating of the dot-pattern interference came between "imperceptible" and "just perceptible" on a six-grade scale ranging from "imperceptible" to "unusable." Evidently the viewer with a monochrome set will be aware of the existence of this interference.

From the results of these tests, and other information collected about the N.T.S.C. system, B.R.E.M.A. conclude that the answer to their first question is "yes"—the system will give satisfactory pictures on easily manufactured receivers in the hands of average viewers.

B.R.E.M.A. answer their second question as follows: "Neither the SECAM nor the PAL system gives results superior to N.T.S.C.; both systems have inferior compatibility performance and the SECAM colour picture is also inferior to N.T.S.C." This, then, implies that they consider there is no justification for departing from

the N.T.S.C. system. Some readers of the report might feel, however, that both the question and the answer are somewhat rhetorical, for B.R.E.M.A. have not put forward any evidence on this matter that would be accepted in all quarters as conclusive. They have presented a number of statements in favour of the N.T.S.C. system—on picture quality, compatibility, stability, receiver cost and other factors—designed to support the existing official U.K. opinion that there is no justification for departing from N.T.S.C. In this way the report has made itself particularly vulnerable to attack from supporters of SECAM and PAL. It might have been on firmer, if more restricted, ground if it had confined itself to the home-viewing tests, which are undoubtedly a valuable contribution to the debate in progress.

These, then, are some of the recent happenings leading up to the C.C.I.R. meeting in Vienna. Whatever the outcome it seems unlikely that there will be an immediate start on establishing a colour broadcasting service in the U.K. It remains for the Government to decide when the country can afford this additional form of entertainment, and this in turn will depend on their overall plans and priorities for the deployment of the country's resources. Thus, in the light of the present economic situation, colour television may still be a few years off.

Analogue-to-Digital Conversion

TWO unusual circuit approaches to analogue-to-digital conversion were described at an I.E.E. colloquium in London on the attainment of high accuracy in a/d conversion. The basic problem is to express the input voltage as a digital fraction of a number representing full scale. Since excellent voltage references are available, the problem reduces to one of dividing the reference voltage with sufficient accuracy. Resistors are commonly used, but as they are subject to changes of value due to temperature and other ambient fluctuations they can set a limit to the accuracy obtainable in practice.

One of the techniques described attempted to overcome this problem by replacing the resistance divider by an inductive divider—the inductive ratio method having now been developed to a state of exceptionally high precision. For a/d conversion the instrumental difficulty was therefore one of using an inductive divider to obtain a fraction of a direct voltage to balance the input voltage. Basically this was done by chopping the d.v. to produce square waves. The input signal and the reference were then compared by an electronic error detector in order to derive the required digital fraction. On this principle a digital voltmeter had been constructed giving an accuracy of 10 parts per million.

The second method dispensed with physical devices for voltage division by using the ratio of two electronically determined time intervals to represent a fraction of the reference voltage. This ratio was in fact the pulse width ratio of a train of square pulses, generated at an accurately determined frequency by a crystal oscillator driving a bi-stable circuit. These pulses operated a silicon transistor switching circuit which switched the reference voltage V_r on and off, and the resulting pulses of V_r were applied to an integrating circuit. The mean direct voltage obtained from the integrating circuit was the product of the reference voltage and the pulse width ratio, so by determining the pulse width ratio accurately an output voltage of known value and accuracy could be obtained from the integrator. In practice a pulse duration accuracy of 10^{-9} second was necessary in order to obtain an overall measurement accuracy of 1 part in 10^6 .

An alternative method using this general approach was to maintain a constant pulse width ratio and to vary the number of pulses generated in order to obtain a required integrator output voltage. A digital measurement was then obtained by counting the number of pulses necessary to balance the analogue input voltage.

WORLD OF WIRELESS

Dissemination of Information

THE National Electronics Research Council (N.E.R.C.), which was set up last July as a "central co-ordinating body which will indicate gaps in research, show where additional effort is required, suggest priorities, and how to prevent unnecessary duplication of research," has issued its first quarterly review. The purpose of the *N.E.R.C. Review* is not only to record the council's work but to review research projects in this country and elsewhere.

One of the main problems being tackled by the Council is the dissemination of information and a considerable amount of space is devoted to this subject in the *Review*. As a result of investigations by a working party the Council has proposed to the Department of Scientific and Industrial Research a three-year project to investigate a computer-based system for the "selective dissemination of information" (S.D.I.) in the field of electronics. The project will be operated on a weekly basis supplying references to English-language periodical articles, reports and conference papers to a "user group" of 800 academic, industrial and Government research workers in electronics. An invitation is extended to those engaged in pure and applied electronics research who would be willing to participate in the S.D.I. investigation to write to the Technical Officer, N.E.R.C., 8-9 Bedford Square, London, W.C.1.

"Pirate" Radio Ban

BRITAIN and six other European countries signed an agreement in Strasbourg on January 22nd to prevent the operation of radio stations "on board ships, aircraft, or any other floating or airborne object" outside national territorial waters. Under the agreement signatories will treat as punishable offences not only the setting up of these stations but also the providing of supplies, equipment, transport or programme matter to them.

The agreement must be ratified by the respective Governments and will presumably necessitate legislation being drawn up to make it an offence in each country to provide such stations with the means of existence.

Radio Show Plans

PLANS are well advanced for this year's London Radio and Television Show which is to be held at Earls Court from August 25th to September 4th, and will take on a "new look." It will be international; will cover every form of sound and vision entertainment for the home; will be a "spectacular" public show; and the emphasis will be on entertainment. Its full title is "The '65 international television radio recordplayer disc taperecorder stereo hi-fi and musical instrument show" which is shortened (over-shortened?—Ed.) to The '65 Show.

On the radio and television side the organizers (Industrial & Trade Fairs) are providing three television distribution channels (two 405 and one 625 lines), and both a.m. and p.m. sound links for demonstration purposes on each stand.

There will be a preview for trade buyers on August 24th. There will not be separate reception areas for dealers as in the past. The whole show will be open to the public although exhibitors will be permitted to use the central section of their stands in which to entertain guests.

The proposed International Radio Show which the Thomson Organisation was planning to hold in Newcastle, also in August, has been cancelled.

Audio Fair

TICKETS for the International Audio Festival and Fair to be held at the Hotel Russell, Russell Square, London, W.C.1, from April 22nd to 25th, are now available. Requests to the editorial office of *Wireless World* for tickets, which admit two, should be accompanied by a stamped addressed envelope. The tickets will not admit to the dealers' session (up till 4 p.m. on the first day) but are valid from 4-9 p.m. on the 22nd, from 11 a.m.-9 p.m. on the 23rd and 24th and from 11 a.m.-8 p.m. on the 25th.

This year's show will have an even stronger international flavour among the 80 or so exhibitors, most of whom will have demonstration rooms as well as booths in the main exhibition area.

Resale Price Maintenance.—When the general ban on the maintenance of minimum resale prices comes into effect many classes of goods will be excluded from the ban until such time as the Restrictive Practices Court has decided whether or not they are to be "exempted" goods for the purposes of the Resale Prices Act 1964." The first list of excluded goods issued on February 12th by the Registrar of Restrictive Trading Agreements, includes sound and television receivers, radiogramophones, record players, tape recorders and reproducers, magnetic recording tape and discs, microphones, loudspeakers, a.f. amplifiers and accessories or parts of gramophones, sound reproducers and recorders.

Technician Engineers.—Formation of the Institution of Electrical and Electronics Technician Engineers, originally proposed in May last year by the Association of Supervising Electrical Engineers, has now been given formal approval by the Board of Trade. There are now two such organizations, the other being the Society of Electronic and Radio Technicians. Details of membership of the I.E.E.T.E. may be obtained from the secretary-designate E. A. Bromfield, who is also general secretary of A.S.E.E., at 26 Bloomsbury Square, London, W.C.1.

"As **Minister of Communications**, which is what the P.M.G. really is, my department is concerned with providing the most efficient communications service to the country as a whole," said the Rt. Hon. Anthony Wedgwood Benn when speaking at the annual dinner of the Telecommunications Engineering and Manufacturing Association in London on February 9th.

Broadcast Receiving Licences.—The number of combined television and sound licences in the U.K. increased during 1964 by 365,199, bringing the total to 13,154,682. Sound only licences now total 2,859,833 (a decrease of 232,328 during the year). Licences for sets fitted in cars rose by 47,496 to 616,300.

Two conferences are being organized by the Institute of Physics & Physical Society for next September. One, on **non-metallic thin films**, will be held at the Chelsea College of Science and Technology, London, on 23rd and 24th, and the other, on **optics in space**, at the University of Southampton from 27th to 30th. The main sessions of the latter conference will include these topics:—material and instrumentation, laser techniques, television techniques, environmental testing and wavelength sampling. Further details and registration forms will be available at a later date from the meetings officer, 47 Belgrave Square, London, S.W.1.

The Secretary of State for Education and Science has appointed 13 members to the **Council for Scientific Policy** of which Sir Harry Massey was appointed chairman two months earlier. Among the members are Dr. J. B. Adams, director of the Culham Research Lab. of the Atomic Energy Authority; Prof. P. M. S. Blackett, of Imperial College of Science, who is deputy-chairman of the Advisory Council on Technology set up by the Minister of Technology; Prof. B. H. Flowers, Langworthy Professor of Physics, Manchester University; and Dr. F. E. Jones, managing director of Mullards, who was formerly deputy director of R.A.E. Farnborough. Sir Harry Massey is chairman of the British National Committee on Space Research and also president of the European Space Research Organization.

Among the members of the twelve-man **Science Research Council**, of which Sir Harry Melville is chairman, are Earl Halsbury, Prof. M. R. Gavin, professor of electronic engineering at the University College of North Wales, and Sir Bernard Lovell, professor of radio astronomy Manchester University and director of the Jodrell Bank Experimental Station.

Industrial Electronics.—A one-day symposium on "Electronics in industry—the next five years" is being organized jointly by the Midlands Sections of the I.E.E. and I.E.R.E. It will be held in the Dept. of Electronic and Electrical Engineering, the University of Birmingham on April 6th. Registration forms are obtainable from G. K. Steel, Electrical Engineering Dept., College of Advanced Technology, Gosta Green, Birmingham 4.

Confederation of British Industry.—If approved by meetings of members of the National Association of British Manufacturers, the Federation of British Industries and the British Employers' Confederation, the three organizations will be amalgamated to form the Confederation of British Industry.

With the object of "promoting the widest use of audio equipment . . . through collective action" the **Federation of British Audio** has been formed. It has 32 founder member companies. Not only British manufacturers of audio equipment but also British companies representing U.K. or overseas audio manufacturers may apply for membership. The first chairman is D. M. Chave, of Lowther Manufacturing Co.

Entry forms for the 1965 **Geoffrey Parr Award** of the Television Society are now available from 166, Shaftesbury Avenue, London, W.C.2. The award is made either to an individual or a team in recognition of an outstanding contribution to television engineering or an associated science. The 1964 award was made to P. Rainger, of the B.B.C., for the development of the electronic television standards converter.

Two new colour filmstrips—"Introduction to colour television" and "The principal periodic elements"—have been introduced by the Mullard Educational Service. The first, of 27 frames, is meant mainly as an aid to technical colleges running courses on colour television servicing. The other, which covers 43 of the elements, is for class use by chemistry and physics teachers. Each filmstrip is available from Unicorn Head Visual Aids Ltd., 42 Westminster Palace Gardens, London, S.W.1, price 25s with teaching notes.

Mullard Film Award.—At the 9th International Exhibition of Scientific Teaching Films, recently held in Padua, Italy, a Mullard film won a bronze award. The film, Pt. II of "Electromagnetic Waves," was one of eleven submitted by the British Council.

Speeding standards is the theme of this year's conference of the British Standards Institution which is being held in London on May 6th and 7th.



Radio-TV House, Paris, which was brought into service last year by the Office de Radiodiffusion-Télévision Française, is featured on a recently issued French postage stamp.

Apprentice Awards.—The 1964 prizewinners in the national awards scheme of the Telecommunication Engineering and Manufacturing Association for apprentices are:—J. R. Baker, B.Sc., graduate-in-training with G.E.C., whose essay was on congestion theory in telephone systems; P. R. Eastwood, S.T.C. student apprentice, whose essay was on the radio altimeter and its function in the automatic landing system; and A. J. Lyons, S.T.C. technician apprentice, whose paper dealt with the mechanized manufacture of the rocking armature telephone receiver. They each received cheques for £25 at the T.E.M.A. dinner on February 9th.

Research Fellowships to enable scientists from academic, industrial or government laboratories (in the U.K. or overseas) to work for a period with established teams at the Mullard Research Laboratories, at Redhill, Surrey, have been established. A research physicist (P. J. Flanders) from the Franklin Institute of Philadelphia is at present spending a year at the Laboratories undertaking work on magnetostriktion.

A series of twelve-month **post-graduate courses** (lectures, tutorials and laboratory and project work) leading to the degree of M.Sc. for students already holding a Bachelor's degree or the equivalent, are being offered by the Electronic and Electrical Engineering Department of the University of Birmingham. Courses, which begin in October (fee £88), are available in information engineering, air traffic engineering, solid state electronic engineering, control engineering or machine control systems.

With the launch from Cape Kennedy, Fla., on February 3rd of **OSO II**—the second orbiting solar observatory—NASA had placed 62 satellites in earth orbit. Of this number 47 are still in orbit, the others having decayed. A further seven satellites are in solar orbit. OSO II has an apogee of 393 miles, a perigee of 343 miles and an inclination of 33 degrees to the equator. It carries equipment for eight experiments to study X-rays, gamma rays and ultraviolet radiation.

OSCAR III.—At the time of going to press the expected launching date for OSCAR III, the satellite intended for amateur use and referred to in the January issue of *Wireless World*, is February 20th or 27th.

A closed-circuit television system has been installed in the recently completed **Royal Festival Hall**, London, to enable latecomers to see and hear the item they would otherwise have missed because they would not be admitted to the auditorium during an item. EMI Electronics have installed a "minicamera," with a wide-angle lens, which feeds a picture of the entire stage to four 23-in receivers in the foyer and two bars. Additional receivers provide a service to several offices.

The **Radio and Electronic Component Manufacturers' Federation** have moved their offices from 21 Tothill Street, London, S.W.1, to 6 Hanover Street, W.1. (Tel.: MAYfair 2472.)

Meeting Cancelled.—Since going to press with the list of meetings on page 156 the joint meeting of the computer groups of the I.E.E. and I.E.R.E. arranged for March 12th in London has been cancelled.

PERSONALITIES

Dudley Saward, O.B.E., has resigned from the managing directorship of Rank-Bush Murphy Ltd. and from the boards of other companies in the Rank Group on which he has served. He leaves the group in April. Mr. Saward joined Bush Radio as managing director designate at the beginning of 1961 after resigning from the managing directorship of Texas Instruments which he joined on its formation in 1956. On the merger of Bush with Murphy to form Rank-Bush Murphy he became managing director. Mr. Saward was chief radar officer Bomber Command from 1942-1945 and was for some time after the war with B.E.A. as controller of navigation and telecommunications. He is a member of the board of the British Space Development Corporation and has been one of the radio industry's representatives on the Postmaster General's Television Advisory Committee. **C. C. Moore**, who was appointed assistant managing director of Bush Radio in 1952 and held the same position in the Bush-Murphy merger has been appointed to succeed Mr. Saward as managing director.

Bernard R. Greenhead, technical controller of ABC Television Ltd., the programme contractors for the North & Midlands I.T.A. stations, has been appointed to the board of the company. From 1936 to 1950 he was with E.M.I. where he was concerned with research and development of television, radar



Bernard R. Greenhead

(AI) and flying-spot scanning. He spent two years with the B.B.C. in the Planning and Installation Dept. before joining High Definition Films Ltd. in 1953 as development engineer where he later became technical controller of Highbury Studios. In 1955 he went to Alpha Television Studios in Birmingham as chief engineer of which he is now director. He has been with ABC since 1958.

Edward E. Rosen, founder in 1920 of the company which is now the Ultra Group, has asked to be released from the chairmanship of the holding company and its operating subsidiary—Ultra Electronics Ltd. **Sir Victor Tait** is acting as chairman for the time being. **J. J. Swallow**, a native of Philadelphia and a member of the executive committee of the Electronics Industry Association of the U.S.A., has been appointed to the board of Ultra Electronics Ltd. and has become deputy chairman and chief executive. He is 58. It will be recalled that a 40% interest in Ultra Electronics is held by Electronics International Capital Ltd. of Bermuda. **A. V. Edwards**, who six months ago was appointed managing director of Ultra Electric (Holdings)—the parent company—and joint managing director of Ultra Electronics, has resigned from the boards of both companies and of their subsidiaries. **F. W. Stoneman, M.B.E., Ph.D., B.Sc.(Eng.), A.M.I.E.E.**, who joined Ultra from Smiths Aircraft Instruments in 1959 as chief engineer and was joint managing director of Ultra Electronics with Mr. Edwards, is now managing director. Dr. Stoneman, who is a graduate of University College, Nottingham, and received his engineering training in the Post Office, was in the Royal Corps of Signals from 1939 to 1954 and retired with the rank of Lt. Colonel.

On the death of P. Perring-Thoms, founder of Radio Rentals, last July, **C. E. M. Hardie, C.B.E.** (then deputy chairman) assumed the chairmanship primarily to see through the pending merger with Rentaset. With the merger completed Mr. Hardie has retired and **J. W. C. Robinson, M.B.E., M.A.**, founder and chairman of Rentaset and managing director of the group, has become chairman of Radio Rentals. Mr. Robinson, who took over the management in 1928 of the company which became Rediffusion Ltd., started in 1932 his own relay and rental companies which were later grouped together to form Rentaset Ltd.

Brigadier J. D. Haigh, O.B.E., M.A., M.I.E.E., F.Inst.P., director of electronics research and development (telecommunications) at the Ministry of Supply before joining Plessey in 1958, has been appointed director and general manager of Semiconductors Ltd. a member of the Plessey Group. Semiconductors Ltd. is integrating its research and production facilities in an enlarged factory at Cheney Manor, Swindon, in preparation for commercial development of solid circuit and integrated electronics generally.

L. J. I. Nickels, B.Sc.(Eng.), M.I.E.E., export marketing manager of Standard Telephones & Cables for the past three years, has been appointed to the newly created position of product planning manager in the marketing department.



L. J. I. Nickels

He joined the company in 1929 as an engineer and was concerned during the war with the technical supervision of the radio receiver development laboratory, and more recently controlled the company's overall research and development programme. The new export marketing manager is **D. R. Jones** who for the past three years has been concerned with military marketing and liaison with NATO on behalf of I.T.T. Europe. He has been with S.T.C. since 1949.

Gordon K. Teal, M.Sc., Ph.D., assistant vice-president and international technical director of Texas Instruments, Inc., has been appointed director of the Institute for Materials Research of the American National Bureau of Standards. He will serve in this government post for two years. Dr. Teal, who is 58, was for 23 years with Bell Telephone Laboratories where he worked with Dr. Shockley on the development of the junction transistor. He has been with Texas since 1953. Dr. Teal originated the grown junction single crystal technique.

Bernard M. Oliver, M.S., Ph.D., vice-president of research and development, Hewlett-Packard Co., Palo Alto, California, has been elected president of the Institute of Electrical and Electronics Engineers. From 1940 to 1952 Dr. Oliver was with Bell Telephone Laboratories working on the development of automatic tracking radar, television and coding systems. He joined Hewlett-Packard as director of research in 1952.

Air Commodore B. H. Boon, O.B.E., B.A., A.M.I.E.E., who has been deputy chief signals officer at Supreme Headquarters Allied Powers Europe since November, 1962, has become senior technical staff officer, Coastal Command in succession to **Air Commodore R. R. Holder**, who has been appointed director of guided weapons (air) at the Ministry of Aviation. Air Cdre. Boon, who graduated at the R.A.F. College, Cranwell, in 1936 and two years later became a signals specialist, was for two years from 1946 inspector of radio services at the Air Ministry. He then spent three years as deputy director of operational requirements at the Ministry before taking command of the Radio Engineering Unit at Henlow, Beds. Later he became chief signals officer at the headquarters of Allied Air Forces Northern Europe, and from 1960 to 1962 was controller of R.A.F. telecommunications at Signals Command HQ. He is 51. Air Cdre. Holder, who is 52, commanded No. 8 School of Technical Training at R.A.F. Weston, Lancs., before going to Coastal Command.

James Kendall, M.A., Ph.D., M.I.E.E., F.Inst.P., has joined Ross-Hatay International Ltd., consultants, of Upper Brook Street, London, W.1, as joint head of the electronics research division. Dr. Kendall, who is a graduate of both London and Cambridge Universities, was for 12 years head of the physical chemistry laboratory of Metropolitan-Vickers (now part of A.E.I.) and has since been with the Plessey Company (where he was head of semiconductor research), Texas Instruments, Microwave Associates, SGS-Fairchild and, since 1963, with Edwards High Vacuum as managing director. From 1949 to 1952 Dr. Kendall was Leverhulme Research Fellow carrying out fundamental research on semiconductors.

E. F. Newley, M.Sc., A.M.I.E.E., has been appointed director of the Weapons Group of the U.K. Atomic Energy Authority in succession to **Dr. N. Levin** who has become a full-time member of the Authority. Mr. Newley, who is 51, and has been deputy director of the group since 1959 spent the early part of his career at the Post Office Research Station, Dollis Hill. From 1949 until he joined the Atomic Energy Authority six years later he was with the Admiralty Scientific Service.

Peter Dye, who has joined Wharfedale Wireless Works Ltd. as managing director, was marketing manager with Racal Electronics and previously spent several years with E.M.I. Ltd. as manager of the recording and relay equipment division. **G. A. Briggs**, who founded the company thirty-two years ago, continues as chairman of Wharfedale Wireless Works which is now a member of the Rank Organisation.

John A. Clark, chairman of the Automatic Telephone & Electric Company, is the first president of the Telecommunication Engineering and Manufacturing Association. Mr. Clark is the elder son of the late Sir Allen Clark, founder of the Plessey Group of which he is now chairman. He is also chairman of Ericsson Telephones and is a director of the British Space Development Company. Educated at Harrow and Trinity College, Cambridge, he received part of his training with P. R. Mallory in Indianapolis, U.S.A. He served during the war in the Royal Navy as a sub-lieutenant.

B. R. Goddard, B.Sc., M.E., since 1962 on the staff of Sydney University, has resigned and joined Racal (Australia) as technical director. After graduating at Sydney University in 1952 Mr. Goddard joined Standard Telephones as a valve engineer and later became a research officer in the Radiophysics Division of the Commonwealth Scientific & Industrial Research Organization, where he worked on radio-astronomy. As a result of a thesis on this work he received his Master of Engineering degree. From 1959 to 1962 Mr. Goddard was lecturer in electrical engineering at the University of New South Wales.

Rex B. Grey, managing director of Standard Telephones & Cables and vice-president of I.T.T. Europe Inc., has been elected vice-president of the American parent company International Telephone and Telegraph Corporation. Mr. Grey graduated from Texas University in 1941 and joined the G.E. Company in 1945 where he stayed for ten years. He then spent several years with the Texas Apparatus Company, of which he was president, and Dresser Industries, of which he was manager of the controls and automation division, before joining I.T.T.

Alan F. Dixon, who before going to the States in 1957 was for four years with British Thompson-Houston Co. working on semiconductor development, has been appointed manager for engineering for Raytheon Company's semiconductor operations at Mountain View, California. He was for a short time with Transitron Corp. and in 1959 joined Rheem Semiconductor Corporation's works at Mountain View which was acquired by Raytheon in 1961. Mr. Dixon graduated in electrical engineering at Durham University.

J. C. Prichard, has been elected to the board of A. P. Besson & Partner Ltd., designers and manufacturers of miniature microphones, earpieces and industrial electronic equipment, of Hove, Sussex. Mr. Prichard is also a director of the parent company, Vactric Control Equipment Ltd., manufacturers of electro-mechanical servo components.

OUR AUTHORS

I. F. Macdiarmid, A.M.I.E.E., one of the authors of the article on correcting colour signal distortion on page 113, has been with the Post Office since 1935 when he joined as a youth-in-training. Since 1948 he has been at the Research Station, Dollis Hill, and, apart from three years when he worked on microwave and satellite communications, has been engaged mainly on research on problems of waveform transmission, particularly in television. He is at present in charge of a group studying these problems. His co-author, **I. J. Shelley, A.M.I.E.E., A.M.I.E.R.E.**, has been with the B.B.C. since 1946. He was for some years with the television group of the Designs Dept. and is now head of signal processing in that department. He was a member of the team responsible for the development of the B.B.C. cablefilm system for transmitting television and has more recently been concerned with investigations into various systems of automatic correction of both monochrome and colour television signal distortions.

J. B. Dance, M.Sc., contributor of the article on tunnel diode measurements in this issue, is lecturer in physics and electronics at Bromsgrove College of Further Education. He started his career in the Zeta group at the Atomic Energy Research Establishment at Harwell and was later a physics lecturer at Dudley Training College for Teachers. Mr. Dance, who is 33, gained his M.Sc. degree for work on photochemical free radical reactions carried out at Birmingham University.

R. H. Pearson, B.Sc.(Eng.), A.M.I.E.E., who describes a simple transistor power supply in this issue is senior lecturer in electronics and telecommunications at the South East Essex Technical College, Dagenham, Essex. Prior to starting teaching eight years ago he was for five years with the Plessey Company working on guided weapon projects.

OBITUARY

Charles R. Belling, M.I.E.E., joint founder director with E. M. Lee of the well-known company bearing their two names, and also founder and governing director of Belling & Co. the electrical manufacturers, died on February 8th on board *Empress of England* while returning from the West Indies. Mr. Belling was 80.

William H. Harrison, technical director of Rank-Bush Murphy, died on February 5th at the age of 58. He joined Bush Radio on the formation of the company in 1932, later becoming chief engineer and in 1952, a director. On the acquisition of Murphy Radio by the Rank Organisation in 1962 Mr. Harrison joined the Rank-Bush Murphy board.

NEWS FROM INDUSTRY

£11½M SEACOM Orders.—Submarine Cables Ltd. (owned jointly by A.E.I. and B.I.C.C.) have received orders, valued at approximately £5,500,000, for about two-thirds of the cable and one-quarter of the submersible repeaters for the second stage of SEACOM, the South East Asia Commonwealth Telephone Cable. The remainder (£5,750,000 worth) is to be supplied by Standard Telephones and Cables Ltd. Stage 1 of the SEACOM project which links Hong Kong with Singapore, via Jesselton in Sabah, came into service in January of this year. Stage 2, for which these orders are placed, is scheduled to be completed by the end of next year and will involve laying more than 4,500 nautical miles of cable between Cairns in Queensland, Australia, and Hong Kong; via New Guinea and Guam. The Australian end of SEACOM will be linked to the COMPAC (Commonwealth Pacific) cable, and will provide the U.K. with a high-quality telephone service with South East Asia via an all-Commonwealth route. Provisions are also being made for the connection of SEACOM to the Japan-U.S.A. trans-Pacific cable (at Guam). The capacity of the link between Cairns and Guam is to be double that of the rest of SEACOM, CANTAT and COMPAC, which are 80-channel systems. SEACOM is a Commonwealth partnership undertaking of five countries—Britain, Australia, Canada, New Zealand and Malaysia. The British partner is Cable and Wireless Ltd, who meet 46% of the total cost of £23,600,000.

NADGE Consortia.—The Univac division of the Sperry Rand Corporation and J. L. Kier & Company (British civil engineers) have joined the consortium formed in September last by Litton Industries to bid for the NATO Air Defence Ground Environment (NADGE) project. The consortium now consists of Associated Electrical Industries, Compagnie Générale de Télégraphie sans Fil, Elliott Automation, I.T.T. Europe, J. L. Kier and Co., Litton Industries Inc. and Univac. Another group of international electronics companies formed to compete for the £110M NADGE contracts has now been announced. This takes in Decca Radar, Compagnie I.B.M. France, I.B.M. Italia S.p.A., and Westinghouse Electric International. Business will be conducted through Westinghouse NADGE Associates, which has been specially formed for this purpose with offices at 1-3 Regent Street, London, W.1.

The Thomson Organisation Ltd. have purchased **d-mac ltd.** (formerly Dobbie

McInnes (Electronics) Ltd.), of 55 Kelvin Way, Glasgow, S.W.2. This is the Thomson Organisation's first venture in the electronics manufacturing field. Dr. A. R. Boyle will continue as the company's managing director.

An instrument hiring service has been established by Livingston Laboratories Ltd., of 31 Camden Road, London, N.W.1. Initially, oscilloscopes will be available, but other instruments will be offered as the scheme develops. Until the project is fully established, a 100-mile radius of London will be observed. The service will operate quite separately from the company's normal sales departments.

Hudson Electronics Ltd., of Peall Road, Croydon, have just completed a **radiotelephone system** for Pressed Steel Commercial Refrigeration Ltd. The network is controlled from Prestcold's offices at Greenford, Middx., with three transmitters—at Highgate Hill, Crystal Palace and Richmond.

A.B. Metal Products Ltd. ceased to be a subsidiary of the Gas Purification and Chemical Company Ltd. on 1st January and was converted into a public company on 20th January. Shares are quoted on the London Stock Exchange. The board of directors remains unchanged.

A.E.P. International Ltd. have moved from Hounslow to Grove House, London Road, Isleworth, Middx. (Tel.: ISLeworth 7447.) They represent a number of overseas companies including Allen Avionics, Central Dynamics Ltd., Cox Instruments, Defence Electronics Inc., Knott Elektronik, Philbrick Researches Inc., Probescope Co. Inc., and the Victoreen Instrument Co. A summary of the companies represented and their products is available on request.

The headquarters of the **service division of Decca Radar Ltd.** has been moved from London to new premises at Purley Way, Croydon. This division controls a service organization comprising more than 1,000 engineers.

Brimar Industrial Tubes.—The Brimar industrial cathode-ray tube (home) sales department has moved from Brimsdown, Enfield, Middx., to the head office of the parent company—Thorn-EMI Radio Valves and Tubes Ltd., 155 Charing Cross Road, London, W.C.2. (Tel.: GERrard 9797.)

Peto Scott Electrical Instruments Ltd., of Weybridge, have opened a new service department at Croydon. All future service communications should be sent to Beddington Lane, Croydon, Surrey. (Tel.: THORnton Heath 9433.)

Photronic Controls Ltd., the manufacturers of industrial and domestic photoelectric control equipment, have changed their name to **Photain Controls Ltd.** They remain at Randalls Road, Leatherhead, Surrey. (Tel.: Leatherhead 2776.)

Cannon Electric (Great Britain) Ltd. have moved from 168 Old Street, London, E.C.1, to 25-27 Bickerton Road, Upper Holloway, London, N.19. (Tel.: ARCHway 3088.)

Machtronics Incorporated (manufacturers of video tape recorders) of Palo Alto, California, is in future to be known as the **MVR Corporation.**

Agencies and agreements

Exchange of Satellite Information.—Under the terms of a recent agreement, technical information on satellites and other spacecraft is to be exchanged between TRW Space Technology Laboratories, of Los Angeles (part of Thompson Ramo Wooldridge Inc.), and Hawker Siddeley Dynamics. This agreement includes electronics.

Clevite Semiconductor Takeover.—The International Telephone and Telegraph Corporation have acquired the American-based semiconductor division of the Clevite Corporation. Also involved in the transaction is the Clevite Corporation's German-based semiconductor subsidiary Intermetall G.m.b.H. and the semiconductor interests of Brush Clevite Ltd., of Hythe, Southampton. Brush Clevite's semiconductor interests are being transferred to Standard Telephones and Cables Ltd., a British subsidiary of I.T.T. To ensure continuity during the transition period, Brush Clevite will continue to manufacture certain of their semiconductor devices for the next few months on behalf of S.T.C.

Honeywell-SAAB Agreement.—The electronic data processing divisions of Honeywell (U.S.A.) and of Svenska Aeroplan Aktiebolaget (SAAB) have signed a reciprocal agreement covering the distribution and selling rights. SAAB will represent Honeywell in their own country (Sweden), Norway, Denmark and Finland and Honeywell will represent SAAB in the United States.

Roband Oscilloscopes.—Under a recent agreement with Roband Electronics Ltd., of Charlwood, Surrey, Livingston

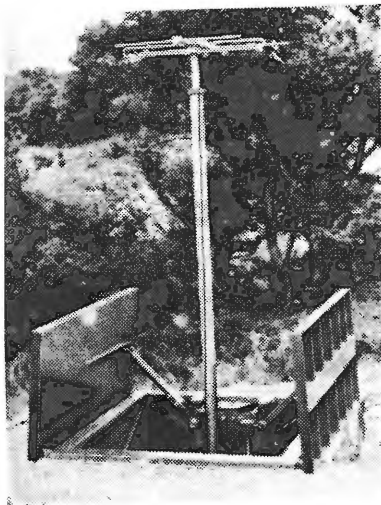

Telescopic masts that stow away into underground bunkers for protection are being produced by A. N. Clark (Engineering) Ltd., of Binstead, Isle of Wight, they can be extended to a maximum height of 70 ft.

Laboratories Ltd. are to market their range of oscilloscopes in the United Kingdom. This will be complementary to their own marketing arrangements in this country. A full after-sales service is to be provided by both companies and will be interlinked.

Distribution of **Bang & Olufsen** and **Sony** products in the United Kingdom is in future to be done through a newly formed company—**Debenhams Electrical and Radio Distribution Co.**, of Eastbrook Road, Eastern Avenue, Gloucester. (Tel.: Gloucester 25634.) They were previously handled by the radio and electrical division of **St. Aldate Warehouse Ltd.**, a member of the **Debenham Group of Companies**.

Chronetics Incorporated, of New York, have appointed **High Volt Linear Ltd.**, of 1 Cardiff Road, Luton, Beds. (Tel.: Luton 23816), as exclusive U.K. representatives. They specialize in nucleonic instrumentation.

Astrodata Incorporated, of California, have appointed **Digital Measurements Ltd.**, of Salisbury Grove, Mytchett, Aldershot, Hants. (Tel.: Farnborough 3551), to market their range of data systems and instruments in the U.K.

The Japanese **Akai** range of domestic tape recorders and accessories is being distributed in the United Kingdom by **Pullin Photographic**, of 11 Aintree Road, Perivale, Middx. **Pullin Photographic** came into being at the end of last year following the acquisition, by **Rank**, of **Pullin Optical Co.** and its subsidiary, **Neville Brown**.

G.E.C. (Telecommunications) Ltd., of Coventry, and **Ateliers de Constructions Electriques de Charleroi (ACEC)**, of Belgium, are to co-operate in the microwave communications field. Under the agreement, ACEC will make and market G.E.C. equipment.

From overseas

Australia

Through one of their existing subsidiaries—**Plessey Pacific Pty. Ltd.**—the **Plessey Group** have acquired the **Rola Group of Companies**, in Australia, at a cost of £1,920,000 sterling. The two main members of the **Rola Group** are: **Rola Company (Australia) Pty. Ltd.**, of Richmond, Victoria, and **Rola Company (N.Z.) Ltd.**, of Lower Hutt, New Zealand. They manufacture radio and television components, magnetic wire and materials, and professional magnetic tape recorders.

Redifon Ltd., are to supply a **flight simulator** costing more than £500,000 to **Trans-Australia Airlines**. It will be used to train air-crews and maintenance personnel for **Boeing 727** jet airliners.

Denmark

The Danish P.T.T. has placed an order with **Telefunken** for 26 **remote control and monitoring systems** for unattended repeater stations.

France

Marconi International Marine Company have received an order, worth £168,000, for the supply of medium- and high-frequency **communications equipment** for sixty-one trawlers now being built in French shipyards for the **Korea Marine Industry Development Corporation**. All of the 140-ton trawlers will be fitted with the same type of installation based on the **Atalanta** receiver and **Disa** transmitter.

Germany

A **traffic control system** based on the **ARCH** computer controlled road traffic system developed by **Elliott Traffic Automation Ltd.**, a member of the **Elliott-Automation Group**, is to be installed in the city of **Munich**. The contract for the project has been awarded to the German firm **Signalbau Huber K.G.**, who will be working in conjunction with **Elliott's**.

Italy

An order worth more than £100,000 has been received by the **Marconi Company** from the **Supreme Headquarters Allied Powers Europe (SHAPE)** for **transportable microwave link equipment**. It is to be used by **Allied Command Europe (ACE)**.

The 20,000-ton Italian passenger liner **Angelina Lauro**, was fitted with the **17,000th** marine radar to come from **Decca Radar Ltd.**

H.F. Radio Telephony Advance

The Research Branch of the Post Office has developed a new type of terminal equipment for high-frequency radio-telephone circuits. It gives improved performance especially when reception conditions are poor and will provide satisfactory service even when two-way communication with conventional equipment is impossible.

"Lincompex"

Basically two extra units are used in the system, a "compressor" in the send unit and an "expander" in the receive unit. These are interconnected and perform complementary functions, hence the name **LINKed COMPressor and EXpander**.

The "compressor" produces a constant output signal which fully modulates the transmitter whatever the level of the input. Even syllable to syllable changes in speech are smoothed out. The "compressor" also produces a frequency modulated output (maximum deviation 100 c/s) that is proportional to speech level in the microphone circuits. This is used as a control signal and put over the s.s.b. radio link, with the compressed speech, but on a separate sub-carrier (within the voice band of any 3 kc/s telephone circuit).

At the receiving end, the compressed speech control signal are separated and the speech is applied to the "expander," a variable gain device controlled by the demodulated f.m. signal to restore the original variations of speech level.

High modulation levels are achieved in existing two-way (loop) systems by the use of constant volume amplifiers which are relatively slow acting so as not to smooth out syllable to syllable variations. There is a considerable overall gain in this type of system and it is necessary to have voice operated switches that allow only one direction of transmission at any one time to avoid oscillation.

Advantages

"Lock-out" conditions can occur in existing systems when conditions are poor, as noise has the same effect as speech and can cause the system to fail in one direction. With the **LINCOMPEX** system, no switching is required as there is a constant circuit level and "lock-out" is impossible.

Another advantage is that there is no noise between breaks in speech as, through the control signal, the "expander" is heavily attenuated during the quiet period. This makes it very difficult for a user to tell whether cable or h.f. radio links are being used.

Wide Interest

Commonwealth countries are showing great interest in the system and the first traffic trials of **LINCOMPEX** have been in progress between **London** and **Delhi** since the end of last year.

SIMPLE TRANSISTOR POWER SUPPLY

By R. H. PEARSON, B.Sc.(Eng.), A.M.I.E.E.

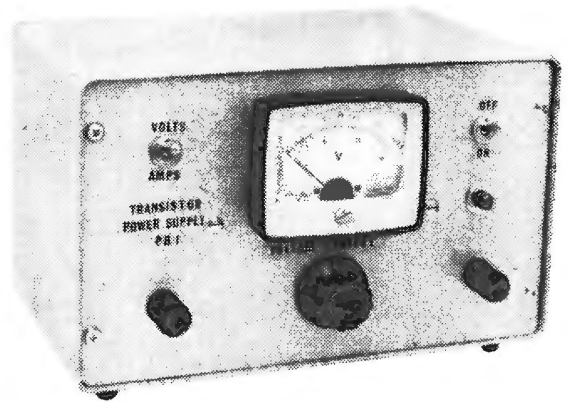

IN experimental work with transistors, variable voltage supplies are invaluable. It helps enormously, when developing a new circuit, to be able to use several supplies simultaneously even though they may be replaced by potential dividers or Zener diodes in the final design. Usually in this situation most of the supplies need not be of very high quality, but they must be cheap and they must be unharmed by overloading. The circuit to be described is arranged not merely to tolerate a short circuit but to like it!

The simplest stabilizer (Fig. 1(a)) uses a Zener diode to obtain reduction of voltage variation due to changes in supply p.d. or in load current. The addition of a potential divider to enable the output to be varied (Fig. 1(b)) spoils the performance with varying loads. This rise in output resistance can be made small only by allowing an excessive current to flow in the potentiometer. A great improvement is possible by adding a transistor connected as an emitter follower (Fig. 1(c)). Some form of overload protection now becomes essential. A fuse is not convenient if it has to be replaced frequently and the commonly used bistable circuit raises the cost and complexity of the power supply. There are, however, some fairly

cheap electromagnetic cut-outs used by model railway enthusiasts which might solve the problem. Immediate protection and low cost are, however, obtainable merely by inserting a dummy load resistor (R) and rearranging the connections as shown in Fig. 2. Now the emitter follower current is limited by the dummy load and a short circuit across the output diverts all the current from the transistor. The dummy load then gets hotter and the transistor cools down. Notice that the reference p.d. from the Zener diode circuit still controls the load p.d. via the transistor, and the emitter follower load (R) absorbs the remainder of the available supply voltage. This resistor will, of course, dissipate quite a lot of power even when the output current is zero, but in a modest supply (15 V, 100 mA.) this is unimportant.

It is possible to design a useful stabilizer using the circuit of Fig. 2, but to obtain an output resistance of about $1\ \Omega$ it is still necessary to allow a considerable current flow in the potentiometer unless an unusually high gain transistor is available. (The output resistance is approxi-

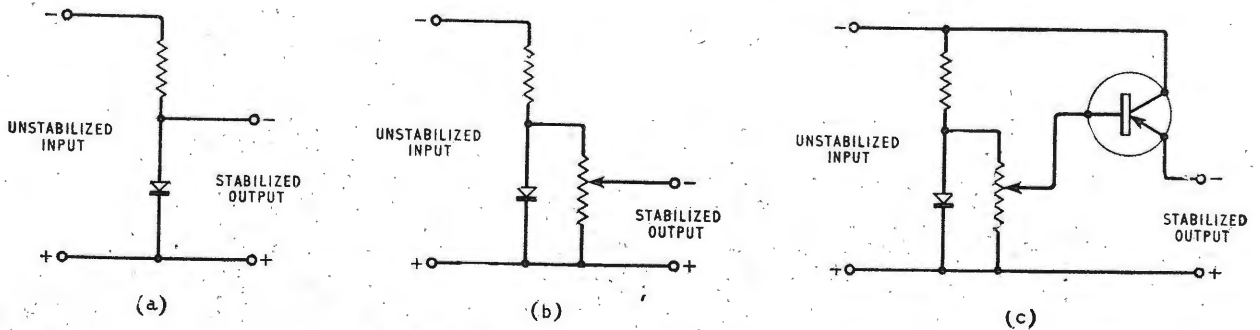

Fig. 1. Development of a simple stabilizing circuit.

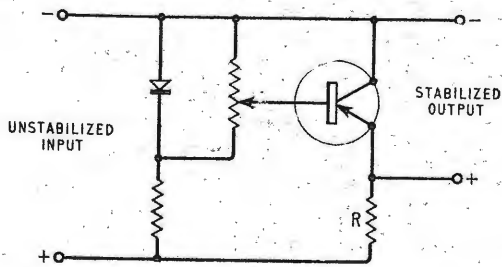

Fig. 2. Addition of resistance R to safeguard the transistor.

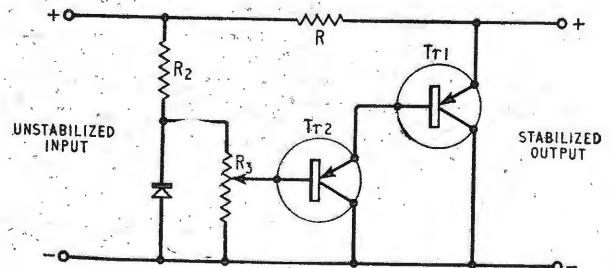

Fig. 3. A Darlington pair gives good results with inexpensive transistors.

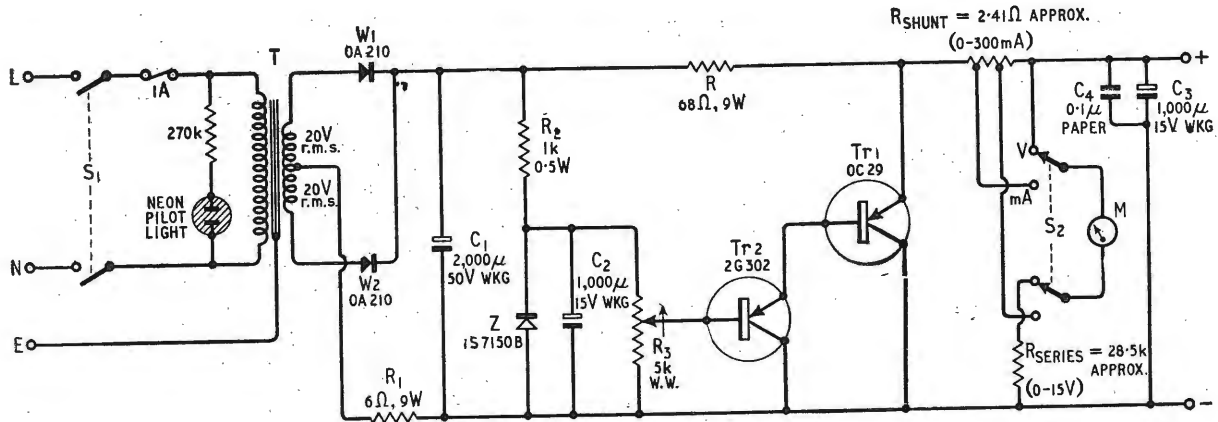

Fig. 4. Practical circuit diagram resistors (other than meter range) $\pm 20\%$.

mately the transistor base circuit resistance divided by the current gain β . A better solution is to retain the smoothness of control of a fairly high resistance potentiometer and the economy of a low-dissipation Zener diode by adding an inexpensive transistor to make a "super-alpha" or Darlington-connected pair, as shown in Fig. 3. This diagram is drawn inverted with respect to earlier ones; it looks neater this way up.

The final design is shown in Fig. 4. It consists of the circuit of Fig. 3, with the addition of a conventional rectifier and of capacitors to reduce hum and high-frequency output impedance. No component is particularly critical and redesign for different output voltage or current should present no difficulty. The OC29 will deal with much higher outputs, but the 2G302 should be changed if an output p.d. of more than 15 V is required from the unit.

Practical construction is entirely a matter of taste and

need not be as large as the prototype, whose size was controlled by the desire to use up a stock of physically enormous capacitors. The best place for the OC29 is on the back or underside of the case, standard mica washers effecting insulation.

Some details of measured performance and an approximate analysis of the stabilizer are given in the appendix. The author wishes to thank the Principal of South East Essex Technical College for permission to publish this article and Mr. R. Bishop for devising the prototype layout.

REFERENCE

"Low-voltage Stabilizer Using Semiconductors," D.E.O'N. Waddington and M. R. Ainley, *Wireless World*, Sept., 1961.

APPENDIX

An incremental equivalent circuit is shown in Fig. (a), in

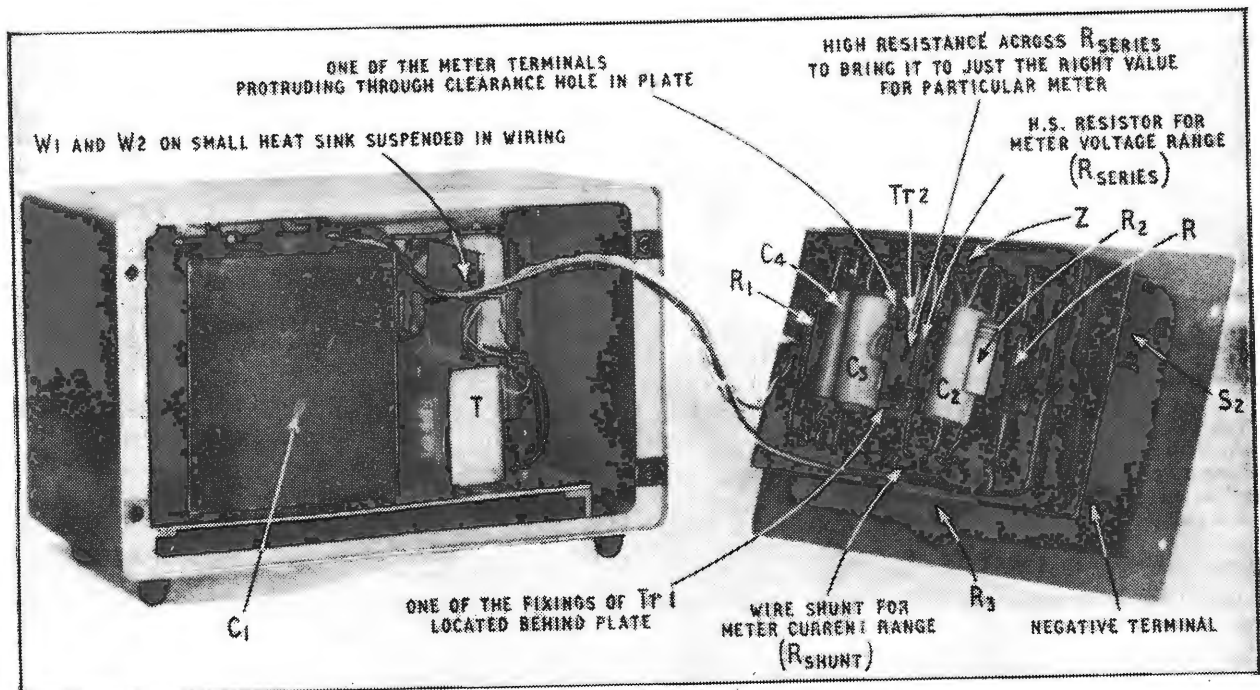

Two views of the prototype unit showing disposition of the principal components.

which the transistors are represented by a simple equivalent circuit (that of Fig. (b), enclosed in dotted lines).

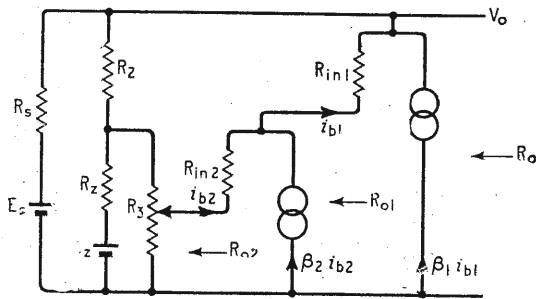

APPENDIX (a)

Output Resistance In Fig. (b), a transistor is fed via a base circuit resistance R_x and its output resistance between collector and emitter is being measured by applying a test p.d. (E). The output resistance is, by definition $\frac{E}{I}$.

$$i_b = \frac{E}{R_x + R_{in}} \text{ so that } I = \frac{E}{R_x + R_{in} + R_x + R_{in}} + \frac{\beta E}{R_x + R_{in}}$$

$$\therefore R_{out} = \frac{E}{I} = \frac{R_x + R_{in}}{1 + \beta} \text{ in which, } R_{in} \approx (1 + \beta)r_e$$

$$\text{and } r_e = \frac{25}{I_o(\text{mA d.c.})} \text{ ohms}$$

$$R_{out} \approx \left(\frac{R_x}{1 + \beta} \right) + r_e$$

In the full circuit (Fig. (b)) the highest base circuit resistance experienced by Tr2 is approximately a quarter of the potentiometer resistance; i.e., $R_{o2} \approx \frac{R_3}{4}$ with R_3 set at the mid-way point. (R_z is much less than R_2 or R_3)

$$\therefore R_{o1} \approx \frac{R_3}{4(1 + \beta_2)} + r_{e2}$$

and $R_{o1} = \frac{R_{o1}}{(1 + \beta_1)} + r_{e1}$. (The shunting effect of R will be negligible).

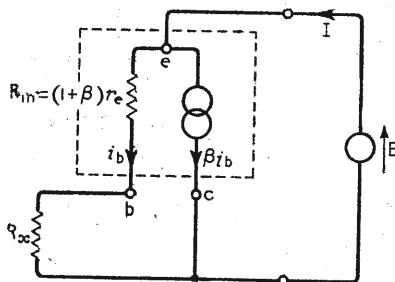

APPENDIX (b)

For example, putting in typical figures:

$I_{e1} = 10\text{mA}$, $I_{e2} = 5\text{mA}$, $\beta_1 = \beta_2 = 50$, $R_3 = 5\text{k}\Omega$
we find $R_o = 0.85\Omega$.

Stabilization Ratio.—The two transistors have a common-collector voltage gain of very nearly unity (except when the load is excessively low in resistance) so that the stabilization ratio is near to that of the Zener diode circuit alone; e.g., at maximum output $S = \frac{dE_s}{dV_o} \approx \frac{R_2}{R_x} = \frac{1000\Omega}{50\Omega} = 20$.

Unless the Zener diode circuit is designed to have much better performance (as it could be), the error in neglecting the extra contribution to output voltage variation $dE_s \times \frac{R_o}{R + R_o}$ is very small.

Performance The result of a load test at four different output settings is plotted in Fig. (c). The short-circuit current of 300 mA can be altered if required by changing R ;

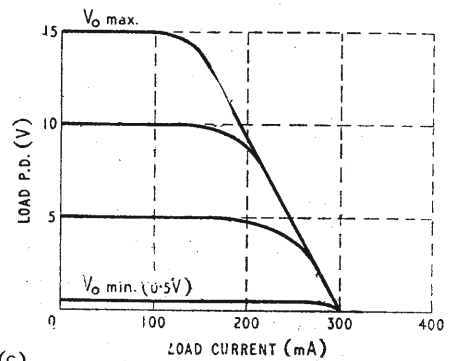

APPENDIX (c)

this could be made a front panel facility. Sample measurements of R_o , S and ripple p.d. are given in the table.

V_o (Volts)	I_o (mA)	R_o (Ω)	S	Ripple (V, pk-pk.)
15	100 20	1.7 1.0	13 18	7.0 4.5
5	100 20	0.6 0.5	44 40	5.0 4.6

The output resistance figures exclude the meter shunt resistance.

THIS MONTH'S CONFERENCES AND EXHIBITIONS

LONDON

Mar. 17-18

Public Address Exhibition

(A.P.A.E., 394 Northolt Rd., South Harrow, Middx.)

Mar. 25-26

Vacuum Technology Conference

(I. Mech. Engrs., 1 Birdcage Walk, S.W.1)

Mar. 29-Apr. 2

LABEX—Laboratory Apparatus & Materials Exhibition

(Scientific Instrument Manfrs. Assoc., 20 Peel St., W.8)

CAMBRIDGE

Mar. 31-Apr. 2

Non-Conventional Electron Microscopy

(Inst. Phys. & Phys. Soc., 47 Belgrave Sq., S.W.1)

MELTON MOWBRAY

Mar. 22-26

Progress in Automation (Conference and Show)

(Production Engineering Research Assoc., Melton Mowbray)

OVERSEAS

Mar. 10-12

Particle Accelerator Conference

(I.E.E.E., Box A, Lenox Hill Station, New York 21)

Mar. 11-16

Festival of Sound

(F.N.I.E., 16 rue de Presles, Paris 15e)

Mar. 22-26

Australia and the Electronics World

(Institution of Radio and Electronics Engineers Australia, Box 3120, G.P.O., Sydney)

Mar. 22-25

International Convention

(I.E.E.E., Box A, Lenox Hill Station, New York 21)

Mar. 23-26

Audio Convention

(Audio Engineering Soc., P.O. Box 383 Madison Sq. Station, New York)

LETTERS TO THE EDITOR

The Editor does not necessarily endorse opinions expressed by his correspondents

The M.O.S.T.

I WAS very interested in the article on metal oxide silicon transistors by Mr. F. Butler (Feb. 1965) as I have developed circuits for using these intriguing new devices in place of electrometer valves.

If a source follower circuit is coupled to a complementary feedback pair of silicon transistors as shown, the input resistance can be as high as $100\text{ k}\Omega$ (10^{11} ohms)! The limit

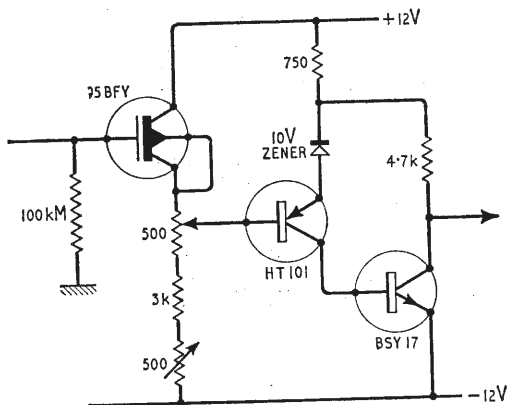

appears to be a resistance which is low enough compared with the gate drain leakage resistance to prevent output drift.

The overall voltage gain of the circuit is 5 and the output resistance is less than 100 ohms. This d.c. amplifier is ideal for use with piezoelectric transducers over the frequency range 0 to 1 Mc/s.

The low noise, low microphony and low sensitivity to temperature of the m.o.s.t. offers interesting possibilities to the circuit designer. One or two further applications to the m.o.s.t. (there must be many more) not mentioned by Mr. Butler are: as a modulator using the substrate as an extra control electrode; as a chopper transistor with zero offset voltage and other switching circuits using the bi-directional properties of the device; and also as a (rather expensive) voltage controlled resistor.

Leigh-on-Sea.

C. J. MILLS

MR. BUTLER'S interesting article brings to mind a two-terminal oscillator circuit, first used as a valve-transistor hybrid, which is apparently well suited for use with a m.o.s.t. instead of the valve. (See accompanying figure.)

The tuned circuit "sees" a negative resistance of approximately $-\alpha/g_m$ where g_m is the mutual conductance of the

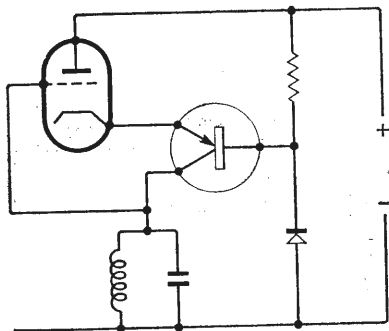

valve. The circuit could perhaps be used (at frequencies well below f_a) as a calibrated negative resistance control being effected by varying the base potential of the transistor.
Croydon.
G. W. SHORT

Units

IN their frantic efforts to prove each other irretrievably incorrect, Mr. D. F. Gibbs and "Cathode Ray" fling around some rather remarkable assertions. Charging Mr. Gibbs with unscientific "quantities" of sugar, "Cathode Ray" provides himself with the highly scientific "thing" electric charge with which to do it, changing dimensions and definitions mid-stream. Dimensions are different in the two c.g.s. systems because of the absence of dimensional constants in definitive equations. Having introduced a fourth unit and dimensional constants, it is then possible to determine experimental values of ϵ_0 and μ_0 . However, if we take precise values of ϵ_0 and μ_0 in order to simply relate old and new systems (although rationalization makes this difficult) it is the fourth unit, the ampere or coulomb, which must then be found experimentally, which is normal practice. "Cathode Ray's" dimensional sugar analogy bears no relation to the argument, since his reference is only to one system of dimensions, not two.

The reason for preference of an m.k.s.A. system to the older unrationalized c.g.s. system is twofold. Primarily m.k.s.A. units are conveniently practical being of the order of everyday usage, and secondly that derivations in the c.g.s. system are not very illuminating, involving half integral powers, and different dimensions between the two systems. If Mr. Gibbs has no wish to take advantage of the new system, he must do so in the knowledge that his derivations of electrical quantities appear in apparently mechanical dimensions only because he has not originally used an electrical quantity in his definitive equations. This is no contradiction to Maxwell's electromagnetic theory since Maxwell's equations involved both electrical and magnetic units, whereas in the c.g.s. system these equations are generally written in mixed or Gaussian units.

Why "Cathode Ray" should find it surprising that physicists and university departments should adopt m.k.s.A. units I really do not know. I do know of at least a couple of university departments of natural philosophy where m.k.s. units are employed in physics lectures and tutorials, yet where the head of the department is still old fashioned enough (and hopeful, with it) to put a copy of *Wireless World* in the library reading room.

Twickenham.

FRANK SMITH.

"CATHODE RAY" (p. 86 February issue) need not be surprised that physicists are using m.k.s.A.; more conveniently called SI (Système Internationale). And Mr. Gibbs might broaden his reading to include the *British Journal of Applied Physics*, especially a paper by P. H. Bigg, Oct. 1964, p. 1243. This describes the system as recommended for universal use by the international General Conference of Weights and Measures. (The U.K. representative is a Fellow of the Institute of Physics.)

SI has been adopted, as standard, for publication by the National Physical Laboratory, The National Bureau of Standards (U.S.A.) and the corresponding laboratories of Canada, South Africa, Australia and New Zealand. It is to be adopted by Russia for all civil, military, scientific and technical use and was made the legal system in France in 1961. The c.g.s. system has few supporters in the profession.

On the matter of representing electrical quantities in terms of mechanical ones, *The Handbook of Physics* (sic) by Condon & Odishaw gives a good account of how the unit of

Charge (or current) is defined in e.s.u., e.m.u. or m.k.s. and shows as clearly as one ever could that although in e.s.u. one may choose $\epsilon_0 = \frac{1}{4\pi}$ one cannot assign zero dimensions to it any more than to the velocity of light for instance. Units and dimensions may be arbitrary but they should not be incoherent.

If I may quote from Dr. Bigg's paper—(The SI will be)—“put into effect progressively, starting with those people and bodies who are more forward looking.” —“it will simplify calculations and teaching will be made easier.”

“Eventually, when children of the present generation reach maturity, SI will be used as a matter of course.”

Sutton Coldfield.

W. M. WRIGLEY

Miniature Selenium Rectifiers

I READ the article in the January issue by Mr. Storr-Best on “Miniature Selenium Rectifiers for Television E.H.T.” with much interest as I myself have experimented with chains of selenium and silicon diodes for the same purpose. However the analysis given for the loss of e.h.t. produced by the forward resistance of the diode is not valid for all values of diode resistance. The analysis assumes that the shape of the diode current is the top of a sine wave, whereas it varies from a triangular shape for resistance-less diodes and small values of diode resistance towards a shape resembling a sine wave for large diode resistances.

The usual analysis of a resistance-less diode considers the effect of loading the parallel LC circuit, which should appear on the left of the circuit in Fig. 1 of the original article, and equating the loss of energy from the oscillating circuit to the energy dissipated in the load resistance R. This gives the well known equation

$$\frac{1}{2} C (E^2 - V^2) = \frac{V^2}{R} T = I_M^2 R T \quad \dots \quad (1)$$

Where C is the value of the capacitor in the oscillating circuit and not the C in parallel with R of Fig. 1, E is the voltage with no load and V the voltage with load R. T is the time of one complete cycle and I_M is the mean output current.

From equation (1) $\frac{V}{E} = \frac{1}{\sqrt{1 + \beta}}$ (2)

where $\beta = \frac{2T}{CR}$

This gives the regulation as a function of the load R and the constants C and T.

The effective d.c. internal resistance is thus given by

$$R_{in} = \frac{E - V}{V/R} \quad \dots \quad (3)$$

which becomes using equation (2)

$$R_{in} = (\sqrt{1 + \beta} - 1)R \quad \dots \quad (4)$$

and for small values of β

$$R_{in} \approx T/C \quad \dots \quad (5)$$

The e.h.t. supply, assuming a perfectly resistance-less diode, thus behaves voltage-wise as if it had an internal resistance T/C, although of course no power is dissipated in this resistance. It can also be shown that the shape of the diode conduction current is also triangular for this case.

If the effect of the diode resistance, R_D , is considered, the energy equation becomes for the same mean output current

$$\frac{1}{2} C (E^2 - V^2) = (I_M^2 R' + I_{rms}^2 R_D) T \quad \dots \quad (6)$$

where R' is the new load resistance adjusted to give the same mean output current I_M , and $I_{rms}^2 R_D T$ is the power dissipated in the diode resistance per cycle.

Equating equations (1) and (6) given that

$$R = R' + \left(\frac{I_{rms}}{I_M}\right)^2 R_D \quad \dots \quad (7)$$

Thus the diode behaves like an internal resistance of value $\left(\frac{I_{rms}}{I_M}\right)^2 R_D$. Unfortunately the evaluation of this expression depends upon knowing the shape of the conduction current and an analysis attempting to do this is far too complicated to be dealt with here. However, assuming that the conduction current is triangular it can easily be shown that

$$\left(\frac{I_{rms}}{I_M}\right)^2 = 1.33 \frac{T}{T_c} \quad \dots \quad (8)$$

where T_c is the conduction time of the diode and if the conduction current is half a sine wave then

$$\left(\frac{I_{rms}}{I_M}\right)^2 = \frac{\pi^2 T}{8 T_c} \approx 1.23 \frac{T}{T_c} \quad \dots \quad (9)$$

Thus the value of the constant in front of T/T_c does not vary very much with the shape of conduction currents that occur in practice.

The total internal resistance of the e.h.t. supply now becomes equal to

$$R_{in} = \frac{T}{C} + \frac{kT}{T_c} R_D \quad \dots \quad (10)$$

where k lies between 1.2 and 1.3.

Example:

Taking $T = 64 \mu\text{sec}$, $C = 12 \mu\text{F}$, $T_c = 2.5 \mu\text{sec}$.

$R_D \approx 100 \text{k}\Omega$, $k = 1.25$ for $I_M = 200 \mu\text{A}$

$$R_{in} = \frac{64 \times 10^{-6}}{12 \times 10^{-12}} + 1.25 \frac{64 \times 10^{-6}}{2.5 \times 10^{-6}} 10^5 \text{ ohms}$$

$$R_{in} = (5.3 + 3.2) \text{ M}\Omega$$

In this particular example the supply has an internal resistance of 5.3 M Ω and dissipates no power and the diode an effective internal resistance of 3.2 M Ω and dissipates power. Thus although the actual figures do not differ very much from those of Mr. Storr-Best, equation (10) does bring out clearly that the internal resistance of the supply is made up of two quite distinct resistances. Typical shapes of conduction currents for a U26 and 480 selenium diodes in series are shown in the accompanying figure.

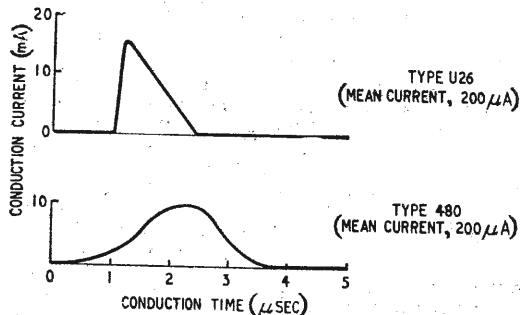

Experiments with long chains of silicon diodes, which had low stored charge and large inverse voltages have shown that a regulation at least as good as a valve may be obtained. These diode chains have a very low forward resistance of only a few ohms so that in theory, provided the stored charge is very low, the regulation should be better than that of a valve, in fact, if they operate so that reverse current flows the regulation is better than that of a valve. If such chains could be made economically, only about 20-30 diodes would be required compared with 400-500 selenium diodes for the same voltage, they would appear to be an ideal solution for solid state e.h.t. rectifiers.

Enfield, Middlesex.

F. D. BATE,

Thorn-AEI Applications Laboratory

The author replies:—

I am grateful to Mr. Bate for the interest he has expressed in this article and for his comments. I agree with him that the diode current is of triangular shape for a zero resistance diode and that it would be more accurate to treat it as such when considering the effective source resistance of the transformer alone—or of a transformer plus a low resistance rectifier such as a valve or a silicon rectifier chain. However, as Mr. Bate shows, the error introduced by this assumption is small and, in my view, the sinusoidal approach is more appropriate to the case of the relatively high resistance selenium rectifier (where r_c , as explained in my article, is a relatively long time constant).

A much greater error is likely to be introduced by the concept of r.m.s. current in a non-linear device. I agree with Mr. Bate's equation (8) provided that the diode can be regarded as a constant resistance, R_D . It may be noted, however, that in my own analysis of forward power dissipation, I took into account the “threshold” voltage of the diode and my integration was therefore based on a forward characteristic equivalent to a

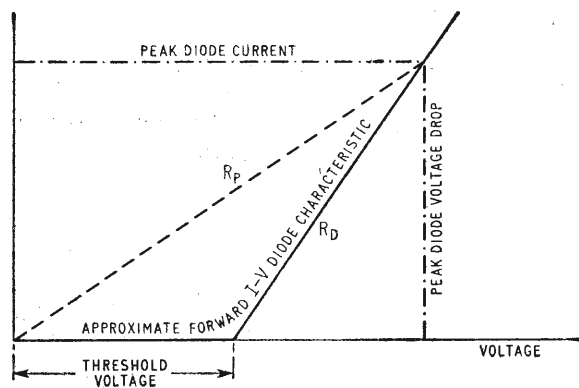

fixed voltage in series with a fixed resistance. Applying the same process to Mr. Bate's analysis my equation for his shape factor, K , in the case of a triangular current becomes $K = 1.33 \left(1.5 \frac{R_P}{R_D} - 0.5 \right)$ where R_P and R_D have the meaning illustrated in the accompanying figure.

It will be seen that when $R_P = R_D$ we have the conditions assumed by Mr. Bate and $K = 1.33$, as in his equation (8). This value would correctly apply when the rectifier voltage drop was much larger than the threshold voltage. In the practical cases that we have been considering, however, the ratio $\frac{R_P}{R_D}$ can be of the order of 1.5, and this makes K just over 2.3. To summarize then, I think it pays to worry about the shape of the diode characteristic more than the shape of the current waveform.

Regarding Mr. Bate's equation (10), whilst I agree with the individual analyses leading to the expressions for the separate components of source resistance, $\frac{T}{C}$ and $K \frac{T}{T_C} R_D$, I do not

think that they can be summed in this simple manner to get the combined effective source resistance. I think that it is necessary to go back to equation (6), armed with the value of I_{rms}^2 derived in terms of K , etc., and repeat the process of calculating the total effective input resistance, as before, in terms of β . When this is done, a much lower total resistance is found than the sum of the two individual resistances. (Compare also with Fig. 3 of my article where it will be seen, for example, that doubling $\frac{r}{R}$ does not double the voltage loss.)

Finally, I heartily agree with Mr. Bate's remarks regarding the technical superiority of silicon diode chains. The advent of the controlled avalanche technique makes multiple series connections simple, safe and reliable—and only the cost prevents them from being offered for this application now. We are, however, at present considering ways in which 20 or more silicon avalanche rectifiers could form a single e.h.t. rectifier device of high efficiency. The commercial target price is a tough one to meet, however.

J. L. STORR-BEST

IN his article in the January issue Mr. Storr-Best is rather optimistic in saying the p.i.v. across the e.h.t. rectifier is $V + E_0$ (page 21).

If we consider the voltage waveform at the anode of the e.h.t. rectifier with no third harmonic tuning as shown in the diagram, we find that during the scanning period ($T_2 - T_1$), the voltage will be negative w.r.t. earth, thus increasing the p.i.v. across the rectifier. So the p.i.v. under nominal operating conditions should be $V + E_0 + V_1$. The average potential at any point across the line output transformer is the boosted voltage (V_{bb}), and the area of the shaded portions of the waveform must be equal. If at zero or low picture tube beam current when $E \approx V$, then

$$V_1 + V_{bb} = \frac{V + V_1}{F} \text{ where } F = \frac{\pi T_2}{2T_1}$$

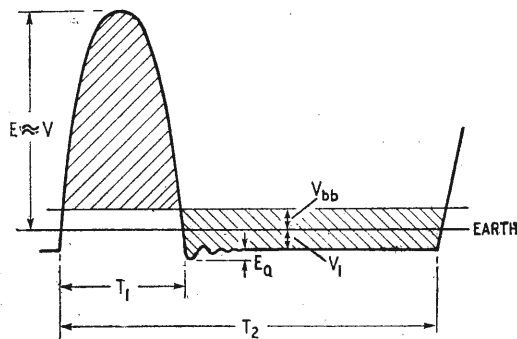

$$\therefore V_1 = \frac{V - V_{bb}}{1 - \frac{1}{F}}$$

For a typical case where $V_{bb} = 800V$; $\frac{T_1}{T_2} = 0.18$ and $V = 18kV$ $V_1 = 1420$ volts

The p.i.v. given by $V + E_0 + V_1$ is of course under nominal operating conditions and to this must be added the effects of spreads in components and operating conditions.

Horley, Surrey.

K. E. MARTIN

The author replies:—

I agree that one can, on closer examination, dissect the rectifier input waveform into the more detailed voltage components shown in Mr. Martin's diagram. The result, however, is the same since all I intended to convey by saying that the p.i.v. approaches $E + E_0$ in my Fig. 2 is that the p.i.v. should be measured from the crest of the positive voltage pulse to the trough of the first negative overshoot pulse (i.e. the same as $E + V_1 + E_0$ in Mr. Martin's diagram). Come to think of it, I used just those words in my general conclusions on page 23! (27 lines from the bottom of the first column).

Tolerances on associated components and operating conditions must of course be taken into account; whereas the nominal p.i.v. may be only 1.1 times the d.c. no load output voltage, under the worst case conditions which may occur due to the adverse combination of control misadjustments, high mains input and component tolerances, this factor may rise to about 1.4. These short-term high stress conditions have been taken into account in rating the rectifiers.

J. L. STORR-BEST

Logic Without Tears

AFTER the recent correspondence in *Wireless World* on the subject of logic symbols it was good to see the careful use made of B.S. symbols by Mr. Henly in his article "Logic Without Tears" in the January issue. So often on tackling a new book or article one is presented with yet another tangle of squares, triangles, circles and semicircles, and I am sure that a significant amount of time and energy is lost by the reader in "getting with it" before he can start on the meat of the work. Even worse, it has been known for a particular symbol to represent one function by one author and quite a different function by another. Since logic symbols are now being applied to an increasingly wider field of engineering it is important that standardization should be encouraged and I would suggest, therefore, that *Wireless World* and its associated publications make a contribution to this cause by refusing* to publish logic diagrams not based on B.S.530.

Having established a suitable vocabulary of symbols there arises the question of how these symbols are to be used. I would say that, apart from preliminary diagrams made by logic designers and illustrative examples of the kind used by Mr. Henly in his article, logic circuit diagrams should follow very closely the physical circuits they are supposed to represent

* *W.W.* does not exclude any good symbols (for instance, for transistors) which can be instantly recognized for what they are, or are clearly defined by the author.—Ed.

so that one may be able to identify each logic symbol with an element of hardware. Some may wish to take this principle further by modifying the B.S. symbols to indicate a particular sort of engineering, for example, to show that a gate has a relatively high power handling capacity or that a binary register is built up from ferrite core elements. But how far can this sort of thing go without detracting from the value of the basic set of symbols?

A point about the algebraic characters used by Mr. Henly is that the character + (standing for OR) is deprecated by the B.S.I. ("Glossary of Terms used in ADP": B.S.3527:1962) and, presumably, so must be its companion × (standing for AND). Personally, I find the characters + and × unambiguous and easy to use but the alternative pair V and & (or a dot, or nothing at all in place of &) being top of the list in the B.S. appears to be generally preferred. An advantage of & is that this character can also be used inside the logic symbol for AND in place of a numeral, as is done in the article.

If I have shed any digital tears at all during recent years they have been lost in the handling of verbal descriptions given to the operation of digital circuits, the problem being what to call the two states of the binary signal. A few examples of the difficulty can be seen in recent articles and correspondence in *Wireless World*, but, Mr. Henly avoids the UP/DOWN, ON/OFF, PRESENT/NOT PRESENT controversy by telling us what the actual voltage levels are. I would suggest that if we were always to talk in terms of POS/NEG the descriptions would unambiguously apply to any circuit, n-p-n or p-n-p, d.c. or pulse and drawn, positive up or negative up!

The difficulty of naming the circuits themselves can be overcome by indicating polarity in the title; for example, the circuit shown in Fig. 14 of the article can be called a negative AND gate, indicating unambiguously that the circuit will perform the AND operation on the relatively negative value of the signal. The reader who knows his De Morgan's Theorem will then know that the circuit will perform the OR operation on the relatively positive value of the signal and he can rename the circuit a positive OR gate if he so wishes. The snag with the circuits shown in Figs. 14-17 is that since the captions chosen are only correct for a particular choice of signal polarity the figures rely too much on the text for their correct interpretation. The reader can, of course, try out the circuit operation for himself to decide which signal polarity was intended to fit the caption but this is perhaps an unreasonable thing to ask of a student.†

The points of criticism I have raised are admittedly small in relation to the usefulness of Mr. Henly's article but I have learnt that it's the small things that count in this subject.

Lee-on-the-Solent, Hants.

A. S. CHESTER

† The reader will not need to experiment if he has read paragraph 4, column 2, page 47 and paragraph 5, column 1, page 48 of Henly's article.—Ed.

The author replies:—

I find myself in general agreement with most of the points which Mr. Chester has raised. There are, however, one or two comments which I should like to make.

1. On the subject of B.S.I. symbols, one of the ulterior motives of the article was to draw attention to this system which seems to be ignored by many (in particular the Electronics Industry). Although the system has its shortcomings, these are generally in isolated symbols and not in the basic system. Although I would like to see the general adoption by W.W. of this system, I appreciate the Editor's desire to maintain complete impartiality on the subject.

Looking at the list of organizations concerned in the preparation of this standard I am amazed at the lack of support which it receives (outside Government departments and the professional institutions).

There has been much discussion recently of incorporating with the logic diagram, information relating to the type of hardware used. The recent I.E.R.E. discussion on the subject brought forth some interesting ideas, but the inherent failing of most lies in the unavoidable "cluttering" of the one diagram with many different types of information. The value of the logic diagram lies in its complete generality which is lost when information is added which is not relevant to the logical functioning of the circuit.

2. After saying so much in favour of B.S.I. symbols above,

I now have to disagree with it on the subject of + and × (or.) versus V and &. I feel the use of the former pair make the algebra more explicit even when one is familiar with it. An equation using these symbols seems more "approachable" than one using + and V (or ∩ and U or the many other symbols in common use). Certainly the symbol V can be used

in the OR gate symbol

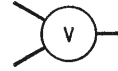

but I feel it has little to commend it in favour of

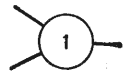

3. I, too, depreciate the use of "up", "down", "on", "off", "Pos" and "Neg", etc. *ad nauseam*, when referring to signal levels. Similarly, I see no need whatsoever (except that B.S.I. recommends) for positive to be "up" and negative to be "down" providing the diagram is suitably annotated (I do not wish to start up an old controversy here!).

H. R. HENLY

Thévenin and Norton

IN my letter appearing in the November 1964 issue (pp. 561-562) under the above heading a wrong statement slipped in which, although it has nothing to do with the actual proof submitted, does invalidate most of what is said in the last paragraph of page 561, since the theorem cannot be extended to arbitrary instantaneous powers in networks containing inductances and capacitances. However, it can be proved (the proof is rather long) that the following relation holds for an a.c. network with general impedances and voltage sources:

$$S = S_0 + E_0' I_1^*$$

where the asterisk (*) stands for complex conjugate and, S = total phasor power (ΣEI^*) supplied by the generator voltage sources under load conditions.

S_0 = total phasor power supplied by the generator voltage sources under no load.

I_1 = current supplied to the load.

E_0' = output open-circuit voltage which would have been supplied by the generator had all its internal impedances been replaced by their complex conjugates.

It should be noted that the above formula yields, for the purely resistive case, a relation which is equivalent to the formerly obtained one.

J. ALTSHULER,
University of Havana

Cuba.

Public Address Show

EQUIPMENT from many countries will be seen at the exhibition being held for two days (March 17th and 18th) at the King's Head Hotel, Harrow-on-the-Hill, Middx. Organized by the Association of Public Address Engineers, it will be open from 10 a.m. to 6 p.m. each day and admission is by trade card or invitation ticket available from the Association at 394 Northolt Road, South Harrow, Middx., or any of the exhibitors listed below.

Audix BB
B.B.C.
C.T.H. Electronics
Clarke & Smith Mfg.
Decca Radio & Television
E.M.I. Electronics
E.M.I. Records
Elcom
Electrical & General Development
Electronics Weekly and Electrical &
Radio Trading
Fi-Cord International
Film Industries
G.P.O.
Goodmans Industries
Grampian Reproducers
Hird-Brown
International Broadcast Engineer
Jennings Musical Industries
Lockwood & Co.
Lustraphone

D. Lyons Associates
Magneta BVC
Minnesota Mining & Mfg.
Pamphonic Reproducers
Philips (Peto Scott)
Politechna
Pye Telecommunications
Radio Retailing
Rendar Instruments
Reosound Engineering
Reslosound
Rola Celestian
Shure Electronics
Sound Coverage
Standard Telephones & Cables
Ultra Electronics
Vivavox
Vortexion
Warren P.A. Equipment
Whiteley Electrical Radio Co.
Wireless World & Wireless Trader

MANUFACTURERS' PRODUCTS

NEW ELECTRONIC EQUIPMENT AND ACCESSORIES

Potentiometer Linearity Tester

THE potentiometer department of Ferranti Ltd. have produced a potentiometer linearity test machine that compares the voltage from a potentiometer under test with that from a standard element contained within the unit. This machine is now available commercially and its output, the voltage difference—which is the linearity error—can be displayed on an oscilloscope for quick routine testing or on a strip chart for permanent recording. The company's address is Ferry Road, Edinburgh, 5.

3WW 301 for further details

Front-wiring Base for Relays

A PLUG-IN base with screw terminals has been developed for use with the octal 8-pin (2 change-over) and the international 11-pin (3 change-over) Kuhnke Universal series of relays. These bases are moulded from Makrolon and all terminal plates and screws are silver-plated.

Associated relays with operating voltages up to 220 volts d.c. and 240 volts a.c. (contact rating 6 amp) are also available from H. Kuhnke Ltd., of 163 Stanwell Road, Ashford, Middx.

3WW 302 for further details

Miniature Bead Thermistors

IMPROVED manufacturing techniques enable Mullard Ltd. to announce four new basic types of miniature bead thermistors that are more robust, have improved electrical stability and will work at higher temperature than types previously available.

These consist of a basic encapsulated bead (VA3100 range) in three different mounting configurations; double-ended glass encapsulated bead (VA3200); glass-dipped bead (VA3400); and "thermometer type" mounted bead (VA3700). The four types are being offered with resistance values ranging from 1 k Ω to 470 k Ω , at 25° C.

3WW 303 for further details

Multri-track Magnetic Recording Head

A THIRTY-THREE-TRACK magnetic recording head for use with one-inch tape has been developed by

Gresham Lion Electronics Ltd., of Lion Works, Hanworth Trading Estate, Feltham, Middx. This head is primarily designed for digital applications where high track packing densities are required, and has an output of 1.5 mV peak-to-peak at 300 bits per inch at 15 in/sec. The head has a gap width of 0.00025 in, and the windings of each track have four terminals that allow the two balanced windings to be connected in series or parallel. When the two coils are connected in series the inductance is quoted to be 2.4 mH \pm 15% and resistance to be within 10% of 22 Ω . Crosstalk (measured by recording simultaneously in phase signals on two alternative tracks and measuring the signal induced in the interposing tracks when reproducing) is claimed to be

better than -20 dB on a square wave signal at, and below, 10 kc/s with tape running at 15 in/sec. The track pitching is 0.030 in and the track width is 0.010 in.

3WW 304 for further details

Modular Racking System

UNIFRAME, a flexible modular kit construction system with 19 in panel widths is now available from C. & N. (Electrical) Ltd., The Green, Gosport, Hants. There are nine basic kits—all of which can be expanded—comprising three different heights, each being available in three different depths. This makes the system equally suitable for single instruments and for complex systems requiring multiple racks. The

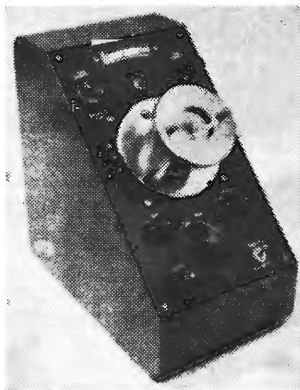

Ferranti potentiometer linearity test machine.

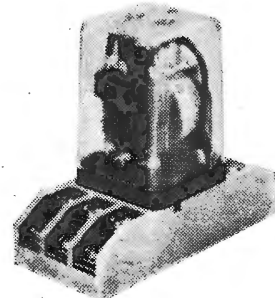

Plug-in relay with front-wiring base from H. Kuhnke Ltd.

Miniature bead thermistors from Mullard Ltd.

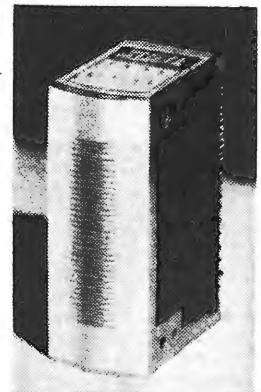
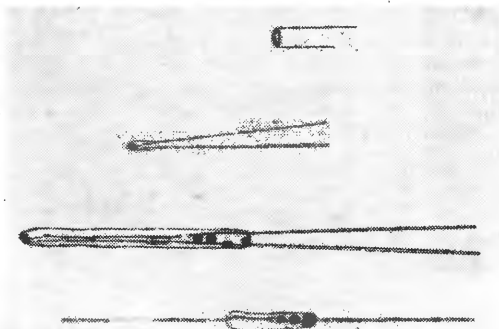

Thirty-three-track magnetic recording head from Gresham Lion Electronics Ltd. It measures 1.5 x 0.6 x 1.25 in.

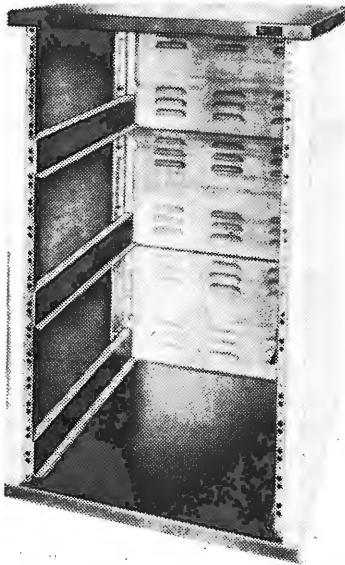

Uniframe modular racking system introduced by C. & N. (Electrical) Ltd.

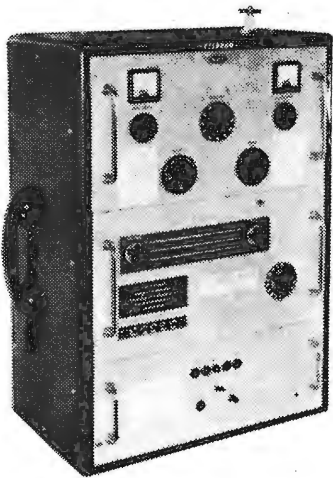

Velorum 100-watt marine radiotelephone from Associated Electrical Industries Ltd.



Miniature blowtorch from Henri Picard & Frère Ltd. Flame size at full power is 3in to extreme tip.

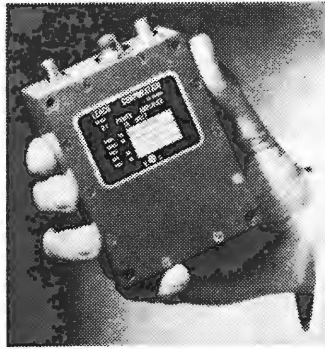

Ten-watt telemetry 216 to 260 Mc/s power amplifier from the Leach Corporation.

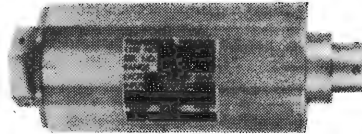

High-output pressure transducer from the Consolidated Electrodynamics Division of Bell and Howell Ltd. It weighs 10 oz.

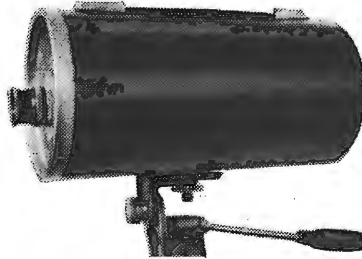

Industrial television camera suitable for direct connection to Band I receivers (Fringe-vision Ltd.).

"Micro-miniature" headset from S. G. Brown Ltd. As can be seen a microphone boom is not needed with this headset, which weighs less than 1 oz.



units can be taken to pieces as easily as they are assembled, either for expansion of the basic kit, or for transporting or storing with a saving of over 85% of space.

The basic principle of the system is the structural strength inherent in the four side members which are bolted to the top and base fabrications; an equipment loading of 100 lb is quoted for a panel height of 10½ in. The enclosure panels are made from p.v.c. covered galvanized sheet steel.

A comprehensive range of accessories is available for the system. It includes front panels in steel or aluminium, chassis and chassis brackets, runners, blower units, plinth units and a selection of enclosure panels.

3WW 305 for further details

Ten-watt R.F. Amplifier

A SOLID-STATE power amplifier that can provide a full 10 watts at 216 to 260 Mc/s with an efficiency of 45%, under specified environmental conditions, is now available from the Leach Corporation, of Los Angeles, California, U.S.A. This amplifier, designated TA-1000, has been designed for telemetry applications and can be driven by any one- to four-watt transmitter. Transistors with special thermal characteristics and improved methods of transferring energy through the heat sinks have achieved a case temperature working range up to +85°C. This has also improved overall size, which is only 2.9×4×1.5 in. and its weight (14 oz.). The TA-1000 can withstand vibrations of 20 g up to 2 kc/s, shock to 150 g and acceleration to 150 g.

3WW 306 for further details

Multi-channel Marine Radiotelephone

DESIGNED for coastal telephony is the new 100-watt Velorum transceiver from the telecommunications division of Associated Electrical Industries Ltd., of Woolwich, London, S.E.18. It is suitable for simplex or duplex operation and has been approved by the British Post Office and the Ministry of Transport for use in compulsorily fitted R/T vessels.

In addition to the coastal telephony bands—in which the receiver section has 12 crystal-controlled spot frequencies—the receiver covers the broadcast, trawler and beacon bands, and also has direction-finding facilities. The transmitter covers the frequency range 1.6 to 3.8 Mc/s—with 11 crystal-controlled spot frequencies—and has a stability of better than 50 parts in 10⁶. It can be modulated up to 90% and has an in-built two-tone alarm, which automatically modulates the transmitter when switched to the distress frequency.

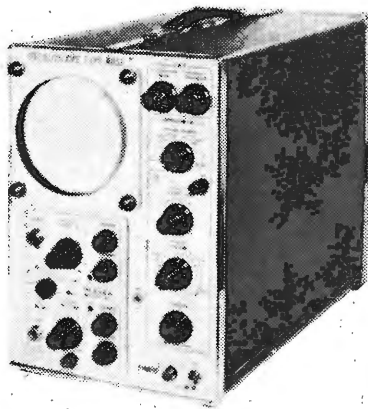

RO55 laboratory oscilloscope from Roband Electronics Ltd.

The Velorum is designed to operate from 115/230 V, 50 c/s supplies. Should it be required to work from a 24 V d.c. supply, a separate static power inverter is available. The overall dimensions of the transceiver are: 32 × 24 × 15 in. It weighs 154 lb.

3WW 307 for further details

High-output Pressure Transducer

DESIGNED to operate under extreme conditions of acceleration, vibration and shock is the Type 4-390 high-output pressure transducer, which is now available from the Consolidated Electrodynamics Division of Bell and Howell Ltd., of 14 Commercial Road, Woking, Surrey. This device is suitable for absolute and gauge measurements of fluids and gases, compatible with 416 stainless steel, and is available in pressure ranges from 100 to 5,000 lb per sq in.

It comprises an unbonded strain gauge sensing element, integral solid-state amplifier and power supply, and provides a five volt d.c. output. Design features include low-pass filtering to suppress high-frequency noise in the output, a high degree of isolation between the power supply and the signal output circuits, and provisions for prohibiting output voltages exceeding a pre-determined level. The rated electrical excitation is 28 volts d.c., 50 mA maximum drain. Output impedance is less than 250 Ω.

3WW 308 for further details

405-line Television Camera

AN all-transistor 405-line, 25-frame (random interlaced) television camera designed to work with Band I television receivers is announced by Fringevision Ltd., of Elcot Lane, Marlborough, Wilts. Known as the Type Vidicon 5.R.F., it will operate from any 210-

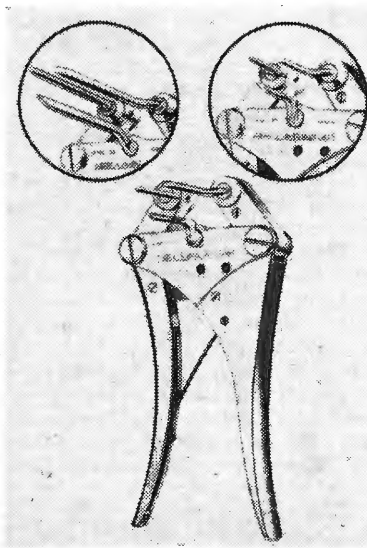

Sleeve fitting tool with three sets of prongs from Hellermann Electric Ltd.

240 V, 50 c/s supply—consumption 20 watts—and provide a 20 mV r.f. output. The target illumination sensitivity is quoted at 0.5ft-candle and the spectral response is said to be similar to panchromatic film. A horizontal resolution of 3 Mc/s is specified.

Special housings are available for this camera and the overall dimensions of the standard housing are: 12 in long × 6 in diameter. A bush for tripod mounting and a "C" type mount assembly, that will accept standard 16 mm lenses, are incorporated. The price of the camera is £91. Rental facilities are available.

3WW 309 for further details

Small Headset

FOLLOWING successful development of a small headset for use in the Mercury space capsule, the communications division of S. G. Brown Ltd. announce these headsets are now available commercially. They consist of a small twin transducer unit containing a magnetic microphone and a magnetic receiver. Pressure variations are conducted to the microphone by means of an acoustic tube, which is claimed to be very efficient in attenuating sibilants and extraneous noise. The output from the receiver is conducted to the ear via a small flexible plastic tube. This is terminated in a moulded germicidal plastic tip which is sensitive to heat and moulds itself into the shape of the aural cavity through body temperature. An alternative earpiece that is anchored just outside the ear is also available.

An ultra-lightweight adjustable headband is available for the transducer assembly. This may not be required as the assembly can be slipped on to spectacles or anchored to a helmet or other headgear. Foot-operated switches are provided and the microphone output can be used directly for dynamic drive circuits. Amplifiers are available to match the microphone to carbon circuits. The company's address is King George's Avenue, Watford, Herts.

3WW 310 for further details

Miniature Blowtorch

POWERED by a gas lighter refill is the "Supa Nova" miniature blowtorch being marketed by Henri Picard & Frère Ltd., of 34-35 Furnival Street, London, E.C.4. This torch weighs less than two ounces, measures 4½ in in length and will operate on either butane or propane gas to provide flame temperatures up to 1,600°C with the air and gas valves fully open.

Running off a standard lighter refill, the torch will give a strong flame for 1½ hours, or a low flame for approximately 2¼ hours. If this is not sufficient, it can be connected to a domestic or industrial cylinder by means of a screw-on grip attachment and a length of rubber tubing. The torch costs £2 5s.

3WW 311 for further details

Universal Sleeve Fitting Tool

INTERCHANGEABLE prongs designed to cover a wide range of sleeve fitting applications are featured in a new tool Hellermann Electric Ltd. have recently introduced. Other features of this new tool include a reduction in weight, built-in stops to control the opening of the jaws, and improved styling that makes the tool easier to handle.

It is supplied as a kit consisting of a body, three sets of prongs, an Allen key (for changing the prongs) and a small bottle of lubricant. The company's address is Gatwick Road, Crawley, Surrey.

3WW 312 for further details

Laboratory Oscilloscopes

TWO precision laboratory oscilloscopes employing tunnel diode trigger circuits are now being manufactured by Roband Electronics Ltd., of Charlwood Works, Lowfield Heath Road, Charlwood, Horley, Surrey. A selection of plug-in vertical deflection amplifiers are available for the two instruments which, incidentally, are fitted with flat-faced, five-inch c.r.t.'s that give a 4 by 10 cm display.

The cheaper of the two instruments

at £139, the RO55, is suitable for applications up to 16 Mc/s and the other, the RO50, to 32 Mc/s. The price of this instrument is £218.

Eight plug-in vertical deflection amplifiers are available for the RO50 giving bandwidths from d.c. to over 30 Mc/s; calibrated sensitivity ranges are from 5 mV/cm-5 V/cm with a 20 nsec rise time to 50 mV/cm-20 V/cm with a 13 nsec rise time. Accuracy is with 3% relative to maximum gain. Two of the plug-in units offer beam switching.

Horizontal deflection is by means of a feedback controlled constant current charging circuit which has a sweep range 0.1 μ sec/cm to 6 sec/cm. Twenty-three calibrated sweep speeds are provided plus an uncalibrated variable control and a five times magnifier that increases the amplifier gain to allow a maximum sweep rate of 0.02 μ sec/cm.

The RO55 is similar in design to the RO50 and rise times vary from 22 to 29 nsec. Sweep speed is from 0.5 μ sec/cm to 0.5 sec/cm, plus a variable control, up to 1.5 sec/cm, and a 5 \times magnifier giving a maximum speed of 0.1 μ sec/cm.

The construction of these scopes is such that servicing may be effected in the majority of cases simply by changing printed circuit boards, which the company offer by express post should a unit fail. (See Industrial News for further sales and service information.)

3WW 313 for further details

Self-tuning Ultrasonic Generator

DESIGNED for use with any one of a number of cleaning tanks (such as the Dawe five-gallon unit that has large radius corners, eight transducers and an effective cleaning area of 126 sq in) is the new self-tuning Type 1191B Soniclean automatic ultrasonic generator

available from Dawe Instruments Ltd., of Western Avenue, London, W.3.

Transistors are used throughout the generator and provide an output of about 300 watts, with a peak rating of 600 watts. The resonant frequency of the generator is around 25 kc/s, and the pulse repetition rate is 100 pulses per second. A feedback loop is used to seek and continuously hold the resonant frequency of the transducers, whatever the tank loading, temperature or other operating conditions. This, the makers claim, ensures maximum efficiency throughout any operation.

Because of the strains imposed by the permanent adjustment to resonance, a new type of lead zirconate titanate transducer has been developed for use with this generator. These transducers, which have the type number 1166, are now being fitted to the standard Dawe tanks, and are also available separately if required.

3WW 314 for further details

Power Transistors

A RANGE of n-p-n silicon power transistors that can be used without heat sinks have been developed by the Silicon Transistor Corporation, of New York, and are available in this country through Walmore Electronics Ltd., of 11-15 Betterton Street, Drury Lane, London, W.C.2. The range so far comprises four units. The first two, designated 2N2033 and 2N2034, both have power ratings of 0.6 watts in free air at 100°C ambient and are mounted in Type TO-5 cans. They have a low saturation resistance—less than 0.30 Ω —and can be used to switch currents of 1 A at repetition rates up to 5 kc/s.

The other two in the range, 2N2828 and 2N2829, are rated at 22.9 watts at 100°C case temperature and are

enclosed in stud-mounted cans ($\frac{7}{16}$ in D.E.S.). These should prove to be useful in series regulated power supply units where high efficiency is the prime consideration. The saturation resistance figure for these two units is the same as the lower rated units, and all have a maximum collector-to-emitter voltage ratings of 80 V.

3WW 315 for further details

Communications Receiver

AN all-transistor communications receiver covering the frequency range 5 kc/s to 30 Mc/s in sixty bands is announced by the National Radio Company Inc., of 37 Washington Street, Melrose, Massachusetts. This receiver, designated HRO-500, covers 500 kc/s in each band with a dial calibration accuracy 1 kc/s over the entire tuning range. The effective scale length for each band is 12 ft and there is $\frac{1}{4}$ in spacing between each kc/s marking; and tuning ratio is 10 kc/s per knob revolution (backlash in less than 50 c/s).

Frequency determination in the HRO-500 is performed by a phase-locked frequency synthesizer which provides all of the necessary oscillator injection signals to tune the 5 kc/s to 30 Mc/s frequency range. Long-term stability is claimed to be equivalent to the best commercial receivers using valves and the maximum variation is quoted to be 100 c/s in any ten-minute period resulting from a 30°C change in ambient temperature or $\pm 20\%$ change in the a.c. supply.

This receiver is suitable for s.s.b., a.m., c.w. and f.s.k. applications and through its low consumption (200 mA at 12 V d.c. with an output of 50 mW and the pilot lamps switched off), it should be of especial interest to those wanting a portable unit. Provisions are made, however,

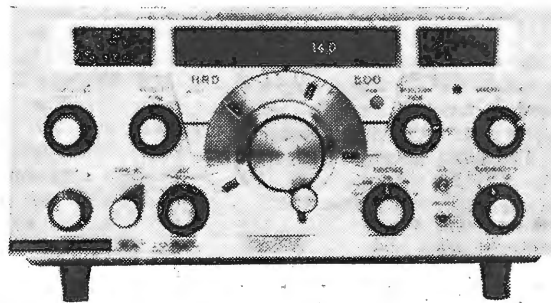

Above: HRO-500 solid-state communications receiver from the National Radio Company Inc.

Left: Dawe Type 1191B Soniclean automatic ultrasonic generator driving a Dawe cleaning tank.

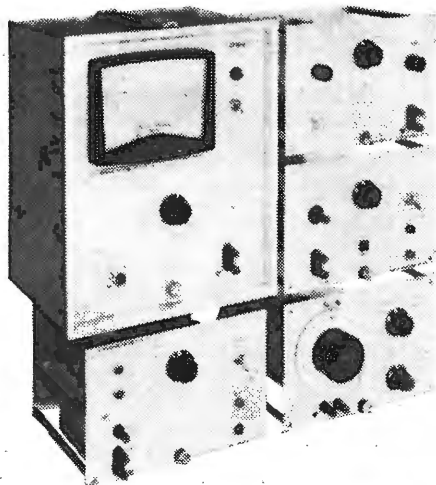

Above: Measuring instruments using a common meter unit made by Dymar Electronics Ltd.



Quick-heating double tetrode u.h.f. power amplifier from Mullard Ltd.

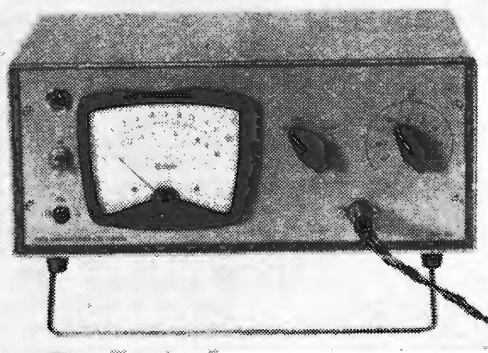

Right: Milliohm meter for low resistance applications from Data Laboratories Ltd.

for the HRO-500 to operate from any 115/230 V, 50 to 60 c/s supply.

A nominal a.m. sensitivity figure of $2.0 \mu\text{V}$ is quoted for a 10 dB signal-to-noise ratio; for s.s.b./c.w. the figure improves to $1.0 \mu\text{V}$. The receiver measures $7\frac{3}{8} \times 16\frac{1}{2} \times 12\frac{1}{4}$ in and weighs 32 lb. It costs £606 2s 9d in the United Kingdom and is available through Ad. Auriema Ltd., of 125 Gunnersbury Lane, London, W.3.

3WW 316 for further details

Measuring Instruments Using Common Meter Unit

A NEW range of measuring instruments that use a common meter unit is announced by Dymar Electronics Ltd., of Rembrandt House, Whippendell Road, Watford, Herts. The basic element in the system, the Type 70 meter unit, incorporates a precision five-inch movement, a comprehensive power supply and will accept any of the instruments in the range. This includes a wideband millivoltmeter (Type 701), d.c. microvoltmeter (Type 721), d.c. kilovoltmeter (Type 722), a.f. signal generator (Type 741) and a noise factor meter (Type 761).

WIRELESS WORLD, MARCH 1965

To illustrate the instruments, the Type 741 employs a Wien-bridge oscillator with automatic amplitude stabilization over the frequency range 30 c/s to 300 kc/s. An accuracy of $\pm 1\%$, ± 1 c/s is quoted, and harmonic distortion is claimed to be less than 1% up to 100 kc/s and less than 2% to 300 kc/s. The maximum output is 10 V r.m.s. at 600 Ω .

Dymar will design and make special purpose instruments, to customer requirement, for use with the common meter unit.

3WW 317 for further details

Milliohm Meter

AN instrument suitable for measuring low resistances is announced by Data Laboratories Ltd., of 3-7 Hatfields, London, S.E.1. A 1 kc/s oscillator provides the energizing current for this meter, which has a terminal voltage of 10 mV and a maximum terminal current of 10 mA. Known as the Type 103, it has a resistance range (full scale) from $1 \text{ m}\Omega$ to 100Ω . The meter is linearly calibrated and the overall accuracy of the instrument is better than $\pm 2\%$. Transistors are used throughout and the dimensions of this portable instrument are: $12 \times 5 \times 6$ in. The consumption is 300 mW.

3WW 318 for further details

U.H.F. Double Tetrode

A QUICK-HEATING u.h.f. double tetrode coded YL 1190 is the latest addition to the Mullard range of quick-heat valves. It has a 1.1 volt, 3.8 amp filament and, from cold, will give a 70% output in less than half a second.

This valve is primarily intended for use in the output and frequency multiplier stages of mobile communications equipment. A single-ended construction is employed in this 500 Mc/s amplifier, thus making it suitable for in-line circuit applications. The power rating at 500 Mc/s is 20.5 watts and 33 watts at 200 Mc/s.

Development sample quantities are available from Mullard Ltd., whose headquarters are at Mullard House, Torrington Place, London, W.C.1.

3WW 319 for further details

Microminiature Filament Lamps

CIRCULAR multi-filament lamps in sizes down to $\frac{1}{8}$ in outside diameter with minimum diameter centre openings of $\frac{1}{16}$ in are being manufactured by the Pinlite Division of the Kay Electric Company, of Fairfield, New Jersey, U.S.A. These lamps, known as "O"-

INFORMATION SERVICE FOR PROFESSIONAL READERS

To expedite requests for further information on products appearing in the editorial and advertisement pages of *Wireless World* each month, a sheet of reader service cards is included in this issue. The cards will be found between advertisement pages 16 and 19.

We invite readers to make use of these cards for all inquiries dealing with specific products. Many editorial items and all advertisements are coded with a number, prefixed by 3WW, and it is then necessary only to enter the number(s) on the card.

Readers will appreciate the advantage of being able to fold out the sheet of cards, enabling them to make entries while studying the editorial and advertisement pages.

Postage is free in the U.K., but cards must be stamped if posted overseas. This service will enable professional readers to obtain the additional information they require quickly and easily.

COMMERCIAL LITERATURE

Lites, operate from low voltage supplies (1 to 6V) and have a life expectancy from 10 to 10,000 hours according to the voltage used. An array of filaments on centres as close as 0.015×0.030 in can be enclosed in single lamps and used in read-out devices and the like with characters only $\frac{1}{16}$ in in height.

A selection of square, elliptical and polygonal shapes are available from stock and single lamps of unlimited shapes can be made to customers' specifications.

3WW 320 for further details

Audio Sweep Oscillator

A SWEEP oscillator covering the range 20 c/s to 20 kc/s on a single logarithmic scale is announced by Dawe Instruments Ltd., of Western Avenue, Acton, London, W.3. The frequency scale is fully rotatable and the instrument has provisions for connection to a Dawe Type 1406 high-speed level recorder, which will automatically record response.

Designated Type 443B, it provides a constant voltage output over the whole frequency range, even when connected to a non-linear or frequency dependent network. The oscillator works on the heterodyne principle. A transformer-coupled output stage is incorporated to

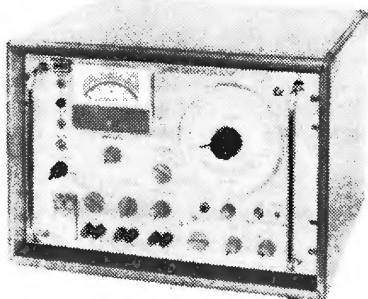

Type 443B audio sweep oscillator with a single continuously variable logarithmic scale (Dawe Instruments Ltd.).

allow impedance selection of either 6, 60, 600 or 6,000 Ω . Output level is variable in 10 dB steps from 125 μ V to 12.5 V.

A specially designed capacitor is used to vary frequency and gives the instrument a scale accuracy of $\pm 1\%$. The output frequency can be modulated internally by up to 200 c/s at any setting. Distortion is less than 0.1% from 200 to 2,000 c/s rising to not more than 1% between 20 c/s and 20 kc/s with an output of 10 volts.

The instrument is available for either rack or bench mounting and weighs 55 lb with case. The price is £270.

3WW 321 for further details

A quick reference chart for "Mullard Special Quality Valves and equivalents" is now available from the industrial markets division of Mullard Ltd., Mullard House, Torrington Place, London, W.C.1. As with the previous editions, valves are listed under CV Services, American and Mullard type numbers. In addition, abridged data is provided in the 1965 edition to assist in the selection of the valve most suited to specific circuit requirements.

3WW 322 for further details

Abridged Valve Data Booklet.—The English Electric Valve Company, of Chelmsford, Essex, are now sending out their 1965 edition of Valve Data. This contains details of their specialized electronic valves and tubes and an index that lists various manufacturers types for which E.E.V. may be used as replacements. Service type numbers are given. Vacuum capacitors are also featured in this 46-page booklet.

3WW 323 for further details

Thermistors for solid state thermal switching are described in a new S.T.C. leaflet (MK/189) which gives details of the PTC range of positive temperature coefficient thermistors, that have been primarily designed for use in industrial equipment. Performance details of these very small spherical components (4.73 mm diameter) are included in the leaflet available from the semiconductor division of Standard Telephones and Cables Ltd., which is based at Footscray, Sidcup, Kent.

3WW 324 for further details

A catalogue giving details of test equipment made by B. & K. Manufacturing Co., of Chicago, for use in radio and TV service workshops, is available from Canadian Instruments and Electronics Ltd., of 35 Waverley Street, Nottingham.

3WW 325 for further details

Copies of an article entitled **Storage of Picoseconds**—A Survey of the Art, written by C. N. Winningstad of Tektronix Incorporated, are available from Tektronix U.K. Ltd., of Beaverton House, Station Approach, Harpenden, Herts. The article has been reprinted from *Electronic Industries* and compares sampling oscilloscope techniques with those of "conventional" oscilloscopes. Present-day capabilities and limitations are also discussed.

3WW 326 for further details

Sound Recording Tapes.—A leaflet entitled "Your Guide to Kodak Sound Recording Tapes" has been sent to us by Kodak Ltd. of Kodak House, Kingsway, London, W.C.2.

3WW 327 for further details

A leaflet entitled "Easy-to-assemble f.m. Tuner" is available from Martin Electronics Ltd., of 154-155 High Street, Brentford, Middx. A technical specification is given for this Martin Audiokit.

3WW 328 for further details

Measuring Instrument.—A new publication in English describing the German Schomand FD1/FDM1 Service Frequency Meter, which should be of particular interest to those concerned with the measurement of crystal-controlled oscillators in mobile communications equipment, is now available from the radar and communication instruments division of Elliott Brothers (London) Ltd., Wigton Gardens, Stanmore, Middx. The basic FD1 unit is a compact frequency synthesiser which can measure frequencies from 30 Mc/s to 90 Mc/s on fundamentals and up to 920 Mc/s on harmonics, with an accuracy of better than 1 part in 10^6 . The FDM1 unit extends the range downwards to zero frequency.

3WW 329 for further details

Styroflex Capacitors.—A catalogue recently issued by Siemens & Halske on their polystyrene capacitors for professional applications is now obtainable from the U.K. agents R. H. Cole Electronics Ltd., of 7-15 Lansdowne Road, Croydon, Surrey. These capacitors, which are quoted to have a high capacitance stability and a low reproducible temperature coefficient, use a stretched polystyrene foil (Styroflex) as the dielectric material.

3WW 330 for further details

Sealectro House Journal.—The January/February issue of the Sealectro house journal *Terminology* is now being distributed. It contains application notes and new product details of Sealectro electronic components. Copies are available upon application to Sealectro Ltd., Hershham Trading Estate, Walton-on-Thames, Surrey.

3WW 331 for further details

An eight-page catalogue giving data on synchro and resolver bridges has been forwarded to us from the Theta Instrument Corporation, of Saddle Brook, New Jersey, U.S.A. Application notes and specifications are included.

3WW 332 for further details

A composite data sheet giving supplementary information on the SGS-Fairchild Diode-Transistor Micrologic (DT μ L) family is now available from SGS-Fairchild Ltd., of 23 Stonefield Way, Ruislip, Middx. It deals with the DT μ L 930 dual gate, DT μ L 931 clocked flip-flop, DT μ L 932 dual buffer, DT μ L 933 dual extender and the DT μ L 946 quad two-input gate. Comprehensive data sheets on the individual elements in the family are also available on request.

3WW 333 for further details

Acheson Dry Film Lubricants is the title of a four-page information bulletin sent to us by Acheson Colloids Ltd., P.O. Box No. 12, Prince Rock, Plymouth, Devon. The described non-liquid films are designed to replace or reinforce conventional methods and can be used to lubricate telephone dial mechanisms to foundry conveyor chains.

3WW 334 for further details

ELECTRONIC LABORATORY INSTRUMENT PRACTICE

By T. D. TOWERS,* M.B.E., A.M.I.E.E., A.M.I.E.R.E.

3.—SIGNAL GENERATORS (AUDIO, R.F. AND PULSE)

AN electronic laboratory needs sources of simulated signals for testing or designing equipment. There are three main groups of such signal generators: audio, r.f., and pulse.

Signal generators are either "service" or "standard-signal". Service generators (sometimes called modulated test oscillators) are inexpensive instruments designed principally for use in testing radio and television receivers. They make only modest claims to precision of output, either in frequency or level. Standard signal-generators (s.s.gs.), on the other hand, are aimed at more serious design or test work, and produce precise, stable, low-distortion signals.

The output arrangements of signal generators are varied, and there is no standardization. Audio generators are often found with screw or spring terminals, or with wander-plug sockets. Higher-frequency and pulse generators, on the other hand, are usually fitted with some form of coaxial output socket. You will come across four fairly common types of such sockets: "standard," "BNC," "N-type," and "Pye." They are not interchangeable, and you will find it useful to keep a supply of leads with different terminals for connection into any type of socket on equipment. Particularly useful terminations are crocodile clips for rapid connections to breadboard circuits.

Before we go on to discuss types of signal generators, a word on nomenclature might prevent misunderstanding. Engineers know roughly what they mean when they talk of "audio" and "r.f." generators. But some people are surprised that the term "audio" in this context can mean anything from a small fraction of 1 c/s up to 1 Mc/s, and "r.f." from 10 kc/s up to 30,000 Mc/s. Here signal generator jargon departs from the preferred standard terminology.

One other matter of terminology is interesting. You can always tell a man used to signal generators by what he calls them. If he talks of audio and r.f. "sig. gens." (abbreviated) and pulse "signal generators" (in full), he belongs to the magic circle.

Audio Sinewave Generators

Nowadays electronics can call for audio sinewave generators to provide frequencies from a small fraction of a cycle per second (e.g. for servo engineers and biologists) up into the

supersonic or low radio frequency range (e.g. for hi-fi engineers testing the stability of negative feedback audio amplifiers above the normal audible range). No single instrument can cope adequately with this enormous range, and separate instruments have had to be evolved for particular bands. Most commercial generators cover the middle-upper part of the audio spectrum, i.e. from normal audio frequencies up into the supersonic. Some of them go so high that they have quite an overlap of frequency with r.f. signal generators.

In the laboratory you will meet with audio generators from many companies. Some familiar names are Airmec, Avo, Dawe, Daystrom (Heathkit), Farnell, Furzehill, Hewlett-Packard, KLB, Levell, Marconi, Muirhead, Philips, Radford, Solartron, STC, Taylor, Venner, Wayne-Kerr and W. G. Pye.

Audio "service" signal generators:—Many of the above manufacturers market models of *service* audio generators. Probably the most widely used are the Advance "J" types, one of which is illustrated at (A) in Fig. 14. This has a range of 15 c/s to 50,000 c/s. It gives a sinewave output of relatively low distortion (less than 2% at full output) and is adequate for at least 90%

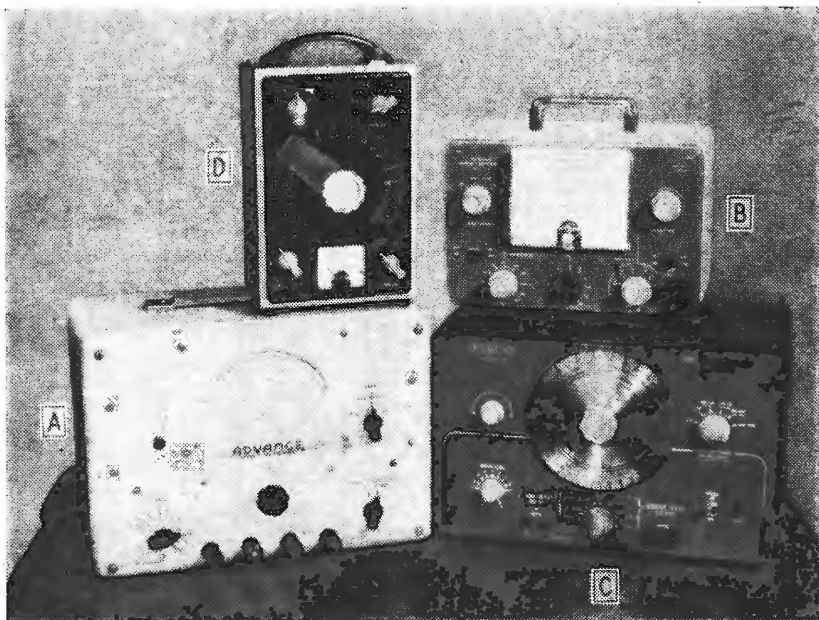

Fig. 14. Commercial Audio "Service" Signal Generators: (A) Advance J1; (B) Daystrom AG-9U; (C) KLB Paco-G34; (D) Levell TG150DM (transistorized).

*Newmarket Transistors Ltd.

of normal lab. requirements. (The model illustrated is an old one that has been in daily lab. use for ten years. Present-day "J" type generators have a modified presentation.)

The Daystrom AG-9U illustrated at (B) in Fig. 14 is another popular sinewave-only generator, with a range from 10 c/s to 100,000 c/s.

As pulse circuits nowadays play an important part in everyday electronics, manufacturers are tending to supply audio service generators with square-, as well as sine-, wave facilities. A good typical example of this is the KLB Paco-G34 illustrated at (C) in Fig. 14, with a range of 7 c/s to 750,000 c/s.

All the above instruments use valves but transistorized service generators are steadily appearing. A good illustrative example is the Levell TG150DM shown at (D) in Fig. 14. It has a frequency coverage of 1.5 c/s to 150,000 c/s, both sine and square wave, and is battery operated for portability.

Audio "standard-signal" generators:—For more exacting audio measurements, you must turn to *standard-signal* generators. In these, the frequency and level of the output can be set accurately and held stable, and waveform distortion is low. With such refinements in performance, of course, these instruments cost more than the service generators.

A good example of an audio standard-signal generator is the Marconi TF2000 shown at (A) in Fig. 15. Transistorized and with a frequency coverage of 20 c/s to 20,000 c/s, it has been designed to meet the exacting demands of testing modern high-quality audio equipment. It therefore has a high degree of linearity, negligible distortion, good frequency and amplitude stability and finely controlled levels of output.

Another precision audio generator, which will be found in common use in scientific laboratories, is the W. G. Pye 11025 pictured at (B) in Fig. 15. It, too, has the typical range coverage of 20 c/s to 20,000 c/s.

Finally, an interesting example of a specialist professional instrument for the hi-fi audio field is the Radford "Low Distortion Oscillator" (not illustrated). It provides sinewaves of extreme purity from 5 c/s to 250,000 c/s. This instrument has less than 0.005 % total harmonic distortion at midband frequencies from its 600-ohm output, and also provides clean square waves up to 150,000 c/s.

In audio generators, designers have in the past devoted much effort to providing the stablest and purest possible

sinewave, with suitable frequency ranges. Over recent years, work at very low audio levels has become much more common (e.g., in testing input stages of sensitive hi-fi amplifiers) and the amount of residual hum and noise on the audio generator output has become significant. When you are working at levels around a millivolt, it is always prudent to inspect the output signal from the circuit under test on a good sensitive oscilloscope to ensure that the hum and noise residuals of the signal generator are not giving rise to spurious readings.

R.F. Sinewave Generators

Probably the most important single instrument used by communications engineers is the r.f. signal generator. Many firms market instruments in this field: for example, Airmec, Avo, Daystrom, Elliott, Furzehill, Hewlett-Packard, KLB, Marconi, Philips, Racal, Solartron, Taylor, Tektronix and Wayne-Kerr.

Commercial instruments fall very roughly into three categories by frequency coverage: (a) "h.f." up to 100 Mc/s, (b) "v.h.f." up to 500 Mc/s and "u.h.f." up to 1,000 Mc/s and above. The terms h.f., v.h.f. and u.h.f. are used loosely here in practice. Some engineers use "m.f./h.f." instead of simply "h.f." The only r.f. signal generator found in common lab. use before the days of television and v.h.f./f.m. receivers was the h.f. type. Nowadays v.h.f. and u.h.f. generators are beginning to appear in most laboratories.

As with the audio generators discussed earlier, you will find two main classes of r.f. generators: service and standard-signal.

H.F. service signal generators.—H.F. service generators are economical instruments designed for the radio service engineer. Nevertheless, they are not limited to this field and make good general-purpose lab. instruments.

The Advance E2 generator shown at (A) in Fig. 16 is a very widely used example of this type. Many readers will know it by sight for it has been a lab. "work-horse" for a long time. Present-day versions of the E2 have a more up-to-date styling than the old model used for the illustration. Typical of h.f. service generators, the E2 covers a range from 100 kc/s to 100 Mc/s in six bands. The output can be either unmodulated or 30% amplitude modulated at 400 c/s.

With the advent of v.h.f./f.m. and television receivers, service h.f. signal generators have tended to widen their coverage and often now extend up to about 250 Mc/s.

This top limit is necessary to provide marker signals for television service sweep generators. A good example of the new-generation h.f. service generator is the KLB Paco-G30 shown at (B) in Fig. 16. This has a range of 160 kc/s to 240 Mc/s.

H.F. standard-signal generators:—Output impedance, output level setting, stability, etc. in the h.f. service generators discussed above are all satisfactory for the field that they are designed for. However, for more refined measurements, e.g., ac-



Fig. 15. Commercial Audio "Standard-signal" Generators: (A) Marconi TF2000 (transistorized); (B) W. G. Pye 11025.

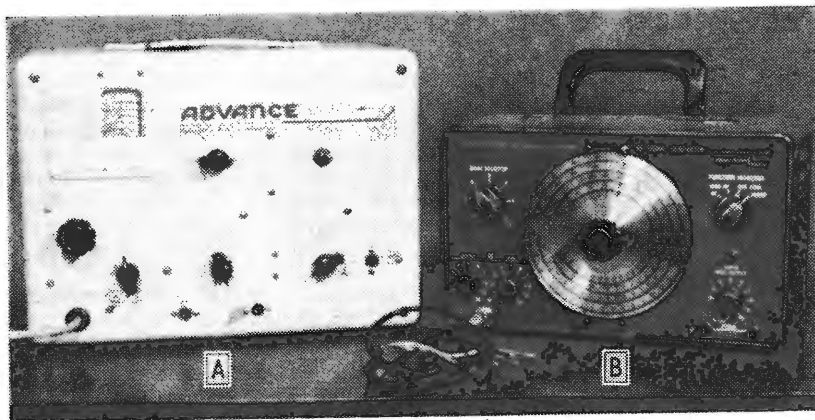

Fig. 16. Commercial h.f. "Service" Signal Generators: (A) Advance E2; (B) KLB Paco-G30.

curate measurement of 470 kc/s i.f. bandwidth, or serious design work on r.f. tuned circuits, you will have to turn to the standard-signal generator.

The Marconi TF144, in its various marks, has been one of the accepted lab. tools of communications design engineers for many years. In its current form it has reached mark TF144H/4. For even greater precision of measurement the same company's TF867 has been a standard, but it is now tending to be replaced by their transistorized TF2002 illustrated at (A) in Fig. 17. This instrument gives high-quality amplitude-modulated output in a carrier range from 10 kc/s to 72 Mc/s. It displays the low drift, low signal leakage and lack of spurious modulation to be expected in good standard-signal generators. Communications engineers often have a requirement for very low-level r.f. signals and the TF2002 meets this with an output variable down to $0.1 \mu\text{V}$. The internal modulation is variable from 20 c/s to 20,000 c/s at a depth continuously variable up to 100%. The TF2002 is very new and the instrument photographed was kindly lent me by Marconi Instruments Ltd.

Where precise frequency control is important, you will usually find in a lab. a crystal-controlled signal generator with a number of fixed spot frequencies available. A good example of this is the Wayne-Kerr FS100 shown at (B) in Fig. 17. This provides rapid selection from twelve crystals of selected frequencies in the range 7.5 Mc/s to 150 Mc/s.

Design points of h.f. signal generators:—In most standard-signal h.f. generators, the accuracy of the frequency calibration is of the order of 1%. Most people accept that a signal generator is primarily a source of accurate voltage rather than frequency. In many commercial instruments, the indicated frequency is made sufficiently accurate to allow easy handling of the instrument, but no more. Some manufacturers, however, include an internal crystal calibrator and the scale can then be set up against the crystal to give an accuracy of the order of 0.1%.

The output voltage of an h.f. signal generator can be quoted either as a source e.m.f. in series with a specified source resistance, or as a voltage which will be developed across a stated load resistance. Usually standard-signal generators are specified by the first method and service generators by the second.

The maximum output voltage available in h.f. generators normally lies in the range 100 mV to 1 V source e.m.f. The 1 V is sometimes desirable when you want to drive a bridge satisfactorily at balance.

Some instruments may display design defects that can lead to erroneous measurements. The more common defects are:

(a) F.M. on a.m., a.m. on f.m., etc. Of recent years, generators have improved in this and manufacturers generally now include limits in their specifications.

(b) Stray radiation. This is not easy to measure and the usual criterion for a standard-signal generator is that the radiation should be low enough to allow sensitivity measurements to be made to below $1 \mu\text{V}$.

(c) Distortion (i.e., a high level of harmonics). This is sometimes difficult to measure and here you are largely in the manufacturer's hands.

(d) Attenuator reaction. Some signal generators have an annoying characteristic that adjustments of the attenuator can alter the frequency, but this defect is less common than it used to be.

As to the modulation characteristics of h.f. signal generators, most low- and medium-priced service instruments have a fixed-depth amplitude modulation (usually 30% at 400 c/s or 1,000 c/s). Standard-signal instruments, by contrast, normally have variable-depth internal modulation and provision for accepting external modulation. The usual range of modulation for these is not less than 30% to 90%. Do not forget that harmonic distortion can become high at high modulation depth. One good standard-signal generator I tested turned out to have about 10% distortion at 90% modulation.

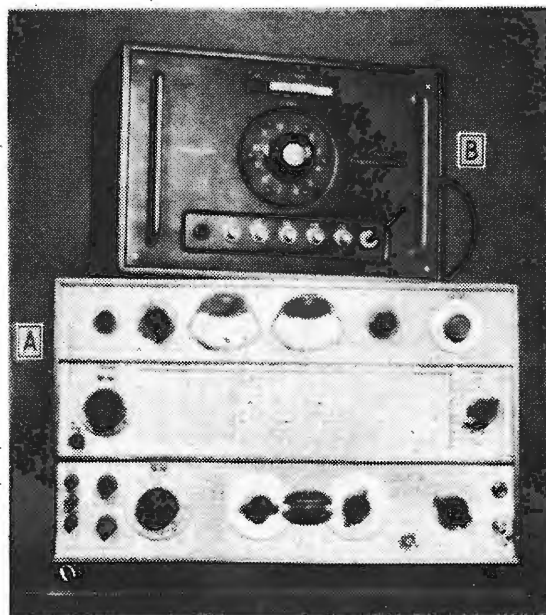

Fig. 17. Commercial h.f. "Standard-signal" Generators: (A) the Marconi TF2002 (transistorized); (B) Wayne-Kerr FS100.

V.H.F. signal generators:—I have characterized h.f. generators rather loosely as ranging up to 100 Mc/s. There is a second class of generators, usually known as v.h.f., ranging up to 500 Mc/s. One of the best known of these is the Marconi TF801 shown at (A) in Fig. 18. V.H.F. standard-signal instruments are available with a.m. or f.m. facilities. The TF801, with a.m., is one I have used widely for years in carrying out transistor parameter measurements from 10 Mc/s up to 200 Mc/s. Its basic specification is impressive. The main signal characteristics are $0.1\mu\text{V}$ to 1 V e.m.f. from 10 Mc/s to 470 Mc/s, with sinewave a.m. up to 90 % at 1,000 c/s. It boasts a scale accuracy of $\pm 0.2\%$ using its internal crystal calibrator. Its output impedance is 50 ohms from a "type N" socket and 75 ohms through a standard coaxial adaptor. Leakage radiation is quoted as "negligible" and f.m. on a.m. has a deviation of less than 1×10^{-5} of the carrier at 30 % modulation.

U.H.F. signal generators:—With modern sophisticated circuits, the v.h.f. signal generators discussed above are becoming quite common features of laboratories. On the other hand the u.h.f. generator capable of supplying signals above 500 Mc/s is not so often needed. Still, as the art progresses, you may expect more and more to come across the u.h.f. instrument. A good example of this type is the Hewlett-Packard 616B shown at (B) in Fig. 18. Its coverage of 1,800 Mc/s to 4,200 Mc/s may seem a little "up in the air" for the run-of-the-mill laboratory, but it is a good illustration of this type of instrument. Designed for ease of operation, it provides direct reading without reference to calibration charts. The r.f. output is directly set and read on a simplified output dial. The output can be c.w., pulse or f.m. modulated.

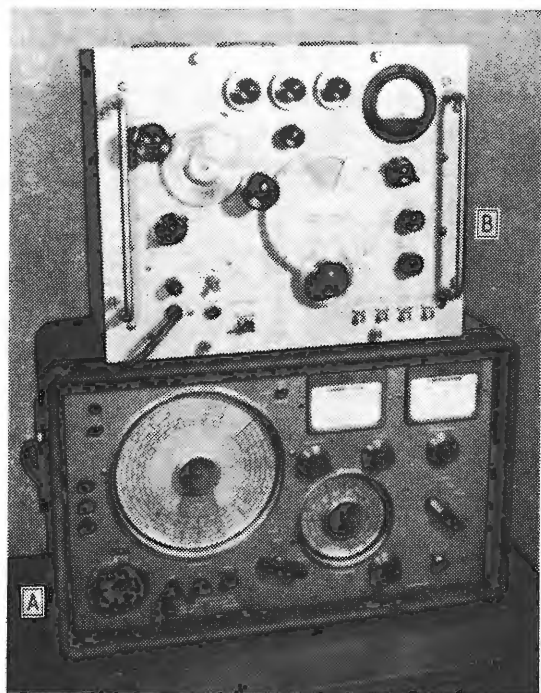

Fig. 18. Commercial v.h.f. and u.h.f. Signal Generators: (A) Marconi TF801; (B) Hewlett-Packard 616B.

Pulse Generators

Since World War II there has been a great increase in the use of pulse circuitry in the fields of radar, digital computing, data transmission, nuclear particle detection and in a variety of biological and medical tests. This means that the pulse generator is finding its way on to lab. benches, and many manufacturers are now in this market: for example, Advance, Dynatron, Hewlett-Packard, KSM, Labgear, Marconi, Philips, Solartron, Tektronix, Venner and Wayne-Kerr.

Service pulse generators:—As with signal generators, pulse generators fall into two classes: service and standard.

Service pulse generators are economical, handy instruments designed to provide simple pulses for any un-exacting circuit requirements. Typical of these is the

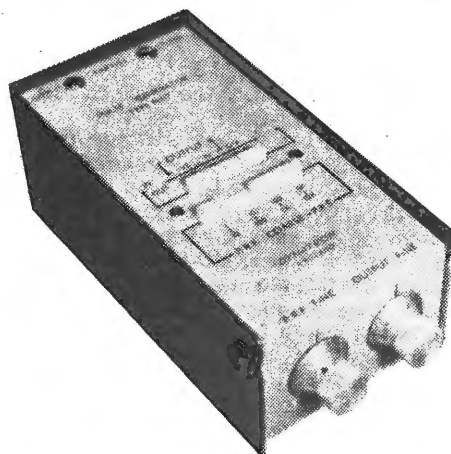

Fig. 19. Commercial "Service" Pulse Generator: Dynatron Electronics N117 (transistorized).

Dynatron Electronics N117 illustrated in Fig. 19. This is a miniature unit designed to provide users of pulse equipment with a simple method of checking if their instruments are functioning correctly. It enables a technician, for example, to inject a known pulse into the early stages of a system in place of a Geiger-Muller tube or a scintillation counter, and makes possible ready calibration of pulse instruments. It provides a frequency coverage from 1 to 10,000 pulses per second and supplies either positive or negative pulses up to 10 V amplitude. Transistorized and battery-driven, it is completely portable. The pulse width is normally set to $10\mu\text{s}$ with a rise and fall time of better than $1\mu\text{s}$, but it can be adjusted by an internal preset control.

Standard pulse generators:—While the N117 is a useful general-purpose piece of test gear, standard pulse generators of more advanced specifications are often required for more serious lab. work in the pulse field. Standard pulse generators fall into two main types: (a) low-p.r.f. instruments capable of producing very short pulses with very rapid rise times in the nanosecond (and nowadays sub-nanosecond) regions, and (b) higher-p.r.f. instruments capable of producing pulses with rise times of a few tens of nanoseconds.

A very widely used low-p.r.f. (100 c/s) pulse genera-

tor with fast rise time is the Tektronix Type R Plug-in Unit (for use with the ubiquitous Tektronix 545 oscilloscope) which is illustrated at (A) in Fig. 20. With a 5 ns rise time and a 700 ns pulse width, this generator has hitherto been very widely used, particularly for transistor switching measurements. It is only now when nanosecond pulse facilities are becoming necessary for testing the new-generation v.h.f. diffused silicon transistors that the Type R unit's usefulness is becoming limited.

To older engineers, the name "Nagard" used to stand for pulse generators rather like "Advance" for h.f. signal generators. Nagard was taken over by Advance some years back, but the Nagard tradition is continued in such equipments as the Advance PG54 shown at (B) in Fig. 20.

Like all good standard pulse generators, the PG54 has a "pre-pulse," in advance of the main pulse, available for oscilloscope triggering. The main pulse can be either positive or negative with respect to earth, and can be varied between 0.1 and 2.0 V with a rise time of less than 10 ns. High-amplitude pulses are available at fixed switched levels of 5 and 10 V. The main pulse width can be varied between 70 and 200 ns in 19 switched ranges with calibrated fine control, and the pulse repetition period between 250 ns and 0.5 second.

Double-pulse generators:—Generators of pairs of pulses with a known time interval between them are useful as standards for measuring short time intervals. A typical application is the measurement of the paralysis time of a pulse counter. Here you start with a long time interval between pulses; then, while you observe the output of the counting circuit, you progressively reduce the inter-pulse interval until the second pulse is not counted.

A good example of a typical double-pulse generator is the Labgear D4147 shown at (C) in Fig. 20. Transistorized, it provides (a) a main pulse (with a p.r.f. range of 1 c/s to 1 Mc/s, a width range of 200 ns to 100 μ s, and a rise time better than 0.1 μ s), (b) a 10-V triggering pre-

pulse, and (c) a second main pulse (from 1 μ s to 1,000 μ s after the main pulse).

Pulse-burst generators:—More complicated trains of pulses may be required for simulating systems employing pulse code modulation, or for synthesizing computer words. Such "pulse-burst" or "programmed-pulse" generators are as yet only occasionally seen in laboratories, but should become more common as pulse circuitry spreads.

Practical Aspects of Signal Generators

So far we have covered the field of generators largely on a "what to use for what?" basis. When you have obtained the right tool, there are some practical "do's and don'ts" you should keep in mind:

- (1) *Do* read the manual of your instrument and learn how to use it properly and to the full.
- (2) *Do* use all the normal instrument precautions, e.g. checking mains tapings and earthing, or allowing adequate heating up time.
- (3) *Do* terminate the generator output with the proper impedance, particularly when you are going to rely on the internal level-set meter and attenuator. Especially, always use the correct coaxial cable for the output of an r.f. signal generator (usually 50 or 75 ohms), as a mismatch can lead to inaccuracies, particularly at high frequencies.
- (4) *Do* keep handy a supply of suitable patch cords, coaxial cables etc. fitted with proper plugs and sockets. (A simple way I use is to keep the leads in a transparent polythene bag tied to the generator. One of the unsolved lab. mysteries is "where do the sig. gen. leads go to?")
- (5) *Do* try not to bump or jar a signal generator. Calibration can so easily be thrown out without your knowing.
- (6) *Do* check calibration of instruments regularly.

(7) *Do* at least check against another signal generator, if you have no other calibration facility, although this may suggest "the blind leading the blind."

(8) *Do* always check that the desired modulation is set before use.

(9) *Don't* forget that distortion of the basic sine or square wave can lead to errors.

(10) *Do* be careful of mains hum at low output levels, particularly with audio generators.

(11) *Do* pay particular attention to earthing in low-level work.

(12) *Don't* use the generator too near the extremes of its range; or, if you must, don't put too easy a trust in your results.

(13) *Do*, finally, always look with a jaundiced eye at what the dials on the front panel say, and believe them only if you have some practical cross check.

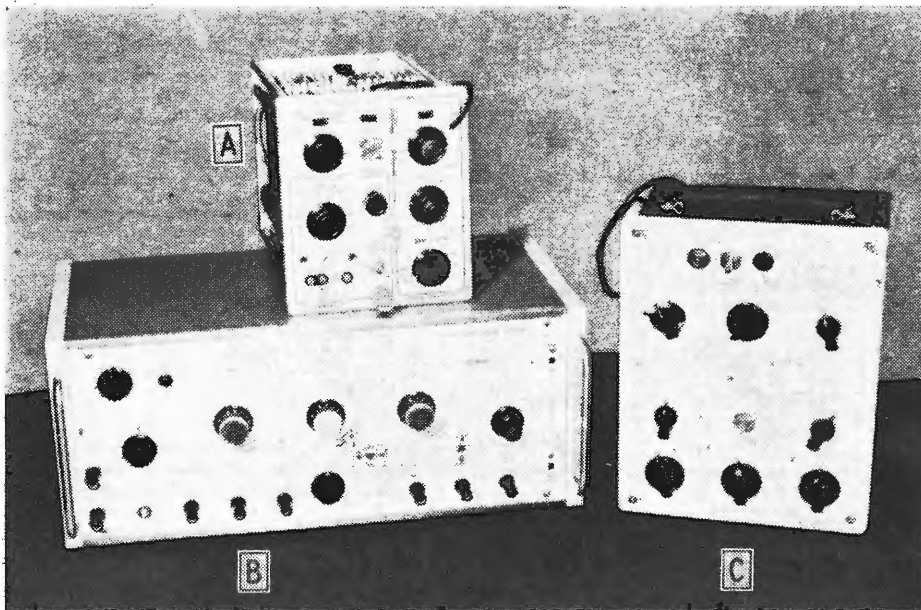

Fig. 20. Commercial "Standard" Pulse Generators: (A) Tektronix Type R Plug-in Unit; (B) Advance PG54 (transistorized); (C) Labgear D4147 (transistorized).

MARCH MEETINGS

Tickets are required for some meetings: readers are advised, therefore, to communicate with the secretary of the society concerned

LONDON

3rd. I.E.R.E.—Discussion on "Teaching of control engineering" at 6.0 at 9 Bedford Square, W.C.1.

3rd. B.K.S.T.S.—"Integrating the use of film and tape in sound recording" by N. Leever at 7.30 at Central Office of Information, Hercules Road, S.E.1.

8th. I.E.E.—"Screened surface waves and some possible applications" by Prof. H. E. M. Barlow at 5.30 at Savoy Place, W.C.2.

10th. I.E.E.—"Electronic circuits—past, present and future" by G. King at 5.30 at Savoy Place, W.C.2.

10th. I.E.R.E.—"Problems in listening" by F. H. Brittain at 6.0 at the London School of Hygiene & Tropical Medicine, Keppel Street, W.C.1.

10th. B.K.S.T.S.—"Telecine facilities for broadcasting" by D. P. Leggatt at 7.30 at Central Office of Information, Hercules Road, S.E.1.

11th. Radar & Electronics Assoc.—"Research technology applied to radar" by Dr. Elizabeth Laverick at 7.0 at Royal Society of Arts, John Adam Street, W.C.2.

12th. I.E.E. & I.E.R.E.—Discussion on "The training of computer engineers" at 5.30 at Savoy Place, W.C.2.

15th. I.E.E.—Discussion on "Irreversible effects resulting from breakdown in transistors and rectifiers" at 5.30 at Savoy Place, W.C.2.

16th. Soc. of Relay Engrs.—"Colour television signal transmission problems" by J. Stuart Sansom at 2.30 at the I.E.E. Savoy Place, W.C.2.

16th. I.E.E.—Discussion on "Periodically varying elements" opened by Prof. D. G. Tucker at 5.30 at Savoy Place, W.C.2.

17th. I.E.E. & I.E.R.E.—"Implanted stimulators for bladder and rectum" by Dr. P. G. Lale at 6.0 at 9 Bedford Square, W.C.1.

18th. Television Soc.—"Video storage for standards converters" by E. Rout at 7.0 at I.T.A., 70 Brompton Road, S.W.3.

22nd. I.E.E.—"Experimental instrumentation in scientific satellites" by Dr. A. P. Willmore at 5.30 at Savoy Place, W.C.2.

23rd. I.E.E. & R.Ae.S.—Discussion on "The problem of aerial installation and siting in modern aircraft" at 6.0 at Savoy Place, W.C.2.

24th. I.E.E., I.Mech.E. & I. Civil E.—Eleventh Graham Clark lecture on "Incentives to invention and innovation" by J. C. Duckworth at 6.0 at 1 Birdcage Walk, S.W.1.

29th. I.E.E.—"Vertical radiation pattern of h.f. curtain arrays on plateau sites" by P. Knight, R. E. Davies and Dr. R. G. Manton at 5.30 at Savoy Place, W.C.2.

31st. Graduates of Instns. of Electrical, Civil & Mechanical Engrs.—"Computers" by B. Z. de Ferranti at 6.30 at the I.E.E., Savoy Place, W.C.2.

31st. B.K.S.T.S.—"Electronic control of reverberation" by James Moir at 7.30 at Central Office of Information, Hercules Road, S.E.1.

BASINGSTOKE

18th. I.E.R.E.—Annual general meeting of the Southern Section at 7.0 followed by "Digital computer control of gas turbine engines" by D. Underwood and C. R. Kill at Basingstoke Technical College.

BELFAST

9th. I.E.E.—"Radio astronomy and the electrical engineer" by Dr. F. G. Smith at 6.30 at Queen's University, David Keir Building.

18th. I.E.E.—Faraday lecture on "Colour television" by F. C. McLean at 7.30 at Ulster Hall, Bedford Street.

BIRMINGHAM

1st. I.E.E.—"The radiophonic workshop of the B.B.C." by F. C. Brooker at 6.15 at the College of Advanced Technology, Gosta Green.

17th. Television Soc.—"Television facilities—3: we film it" by D. Martin at 7.0 at the College of Advanced Technology, Gosta Green.

29th. I.E.E.—"Solid state electronics" by G. T. Wright at 6.0 at the James Watt Memorial Institute.

BOURNEMOUTH

3rd. I.E.E.—"Applications of computers" by P. J. Titman at 6.30 at the Municipal College, Lansdowne.

BRISTOL

9th. Television Soc.—"Loudspeakers" by K. F. Russell at 7.30 at the Royal Hotel, College Green.

10th. I.E.E.—"Present day trends in microwave technique" by Professor G. D. Sims at 6.0 at The University.

24th. I.E.R.E. & Brit. Computer Soc.—"Electronics and process control" at 7.0 at The University Engineering Laboratories.

CAMBRIDGE

11th. I.E.E.—"Adaptive control systems" by Dr. P. E. W. Grensted at 8.0 at the University Engineering Dept.

CARDIFF

10th. I.E.R.E.—"Electronic timing" by A. McKenzie at 6.30 at the Welsh College of Advanced Technology.

19th. Television Soc.—"A medium screen colour television projector" by P. Lowry at 7.30 at the Royal Hotel.

22nd. I.E.E.—"Trends in semiconductor developments" by D. D. Jones at 6.0 at the South Wales Institute of Engineers, Park Place.

29th. I.E.E. & I.E.R.E.—"Computers in the control of processes: the coming revolution in industry" by Dr. D. N. Truscott at 6.0 at the Welsh C.A.T., Pharmacy Lecture Theatre.

CHELMSFORD

1st. I.E.E.—"Electronics—an integral part of the modern aircraft" by B. J. Infield at 6.30 at the Lion and Lamb Hotel.

CHESTER

1st. I.E.E.—"Fuel cells—a branch of electrochemical engineering" by Dr. A. B. Hart at 6.30 at the Town Hall.

CHRISTCHURCH

24th. I.E.E.—"Environmental testing" by H. E. B. Hammersley at 6.30 at the King's Arms Hotel.

COVENTRY

15th. I.E.R.E.—"Synchronous satellite communication" by F. J. D. Taylor at 7.15 at the Lanchester College of Technology.

DUNDEE

10th. I.E.E.—"The UK3 satellite" by H. J. Sketch at 7.0 at Queen's College.

EDINBURGH

9th. I.E.E.—"The UK3 satellite" by H. J. Sketch at 6.0 at the Carlton Hotel.

17th. I.E.R.E.—"Hybrid and analogue computers" by A. J. Collins at 7.0 at the Department of Natural Philosophy, The University.

EVESHAM

15th. I.E.E.—"The development of a line-store standards converter" by E. R. Rout at 7.30 at the B.B.C. Training Dept., Wood Norton.

GLASGOW

8th. I.E.E.—"The UK3 satellite" by H. J. Sketch at 6.0 at the University of Strathclyde.

18th. I.E.R.E.—"Hybrid and analogue computers" by A. J. Collins at 7.0 at the Institution of Engineers and Shipbuilders, 39 Elmbank Crescent.

LEEDS

3rd. I.E.R.E.—"Teaching machines" by Dr. Max Sime at 6.30 at the University Electrical Engineering Department.

LEICESTER

16th. Television Soc.—"Developments in Hi-Fi" by B. J. Webb at 7.15 at Vaughan College, St. Nicholas St.

25th. I.E.R.E.—"Electronics in automobile research" by R. A. Evans at 6.30 at The University.

LIVERPOOL

8th. I.E.E.—"Medical electronics" by Dr. F. Hepburn at 6.30 at the Royal Institute, Colquitt Street.

LOUGHBOROUGH

9th. I.E.E.—"Computers in control of processes" by Dr. D. N. Truscott at 6.30 at the College of Technology.

MANCHESTER

11th. I.E.R.E.—"Recent techniques in magnetic recording" by W. Silvie at 7.0 at the College of Science and Technology.

NEWCASTLE-UPON-TYNE

1st. I.E.E.—Discussion on "Current problems of electronic gear in power stations" at 6.30 at the Rutherford College of Technology.

10th. I.E.R.E.—"Some applications for microwave techniques" by J. Bilbrough at 6.0 at the Institute of Mining and Mechanical Engineers, Westgate Road.

NEWPORT Lo.W.

26th. I.E.E.—Lecture and film on "History and development of radar" by P. Bradsell at 6.30 at the Isle of Wight Technical College.

PAISLEY

23rd. E.E.E.—Discussion on "Educational television" at 6.0 at Paisley College of Technology.

PLYMOUTH

25th. I.E.E. & I.E.R.E.—"Electronics and business management" by W. C. Henshaw at 7.0 at Plymouth Technical College.

PORTSMOUTH

3rd. I.E.R.E.—"Digital computers in road traffic control" by H. A. Codd at 6.30 at Highbury Technical College, Cosham.

17th. I.E.E.—“The analysis of low-frequency electrical noise” by N. C. Baust and M. R. Harknett at 6.30 at the Portsmouth College of Technology.

PRESTON

10th. I.E.E.—Films “Friendship 7” and “Tereshkova—woman in space” at 7.30 at the Harris College.

SHEFFIELD

2nd. I.E.E.—Faraday lecture on “Colour television” by F. C. McLean at 10.0 & 2.30 for students and at 7.30 at City Hall.

SOUTHAMPTON

9th. I.E.E.—“Semiconductor optical devices” by F. D. Morton at 6.30 at The University.

THURSO

11th. I.E.E.—“Digital computers in road traffic control” by H. A. Codd at 7.0 at the Technical College.

WOLVERHAMPTON

10th. I.E.E.—“Radio-astronomy” by H. Gent at 7.15 at the College of Technology.

CLUB NEWS

Birmingham.—“Mobile operation” is the title of the lecture to be given by R. Palmer (G5PP) at the meeting of the Slade Radio Society on March 5th. Designs for the construction of s.s.b. equipment will be considered by J. Tiptaft (G3MVT) on March 19th. Meetings are held at 7.45 at Church House, High Street, Erdington.

Derby.—Weekly meetings of the Derby and District Amateur Radio Society are held on Wednesdays at 7.30 at 119 Green Lane. At the meeting on March 17th T. Darn (G3FGY) will speak about servicing. On the 24th F. C. Ward (G2CVV), the club secretary, will discuss making simple voltmeters and on the 31st B. J. C. Brown (G3JFD) will talk about the morse code.

Halifax.—“Radio on stamps” will be discussed by Mrs. M. I. Shaw (G3OMM) at the March 2nd meeting of the Northern Heights Amateur Radio Society. A fortnight later a lecture on “Wide diffusion hi-fi” will be given by Dudley Johnson. Meetings are held at 7.30 at the Sportsman Inn, Ogdon.

Heckmondwike.—J. W. Swinnerton (G2YS), a member of the R.S.G.B. Council, will be speaking about the training of young people in amateur radio at the meeting of the Spen Valley Amateur Radio Society on March 4th. At the meeting on the 18th a representative of British Railways will talk about electronic equipment in marshalling yards. The club meets fortnightly at 7.30 at the Grammar School, High Street.

Leamington Spa.—At the March 22nd meeting of the Mid-Warwickshire Amateur Radio Society the subject to be discussed is frequency meters and crystal calibrators. Fortnightly meetings are held at 7.45 at Harrington House, Newbold Terrace.

Melton Mowbray.—An illustrated lecture—“Basic valve circuits”—based on Mullard film strips will be given at the March 25th meeting of the Melton Mowbray Amateur Radio Society at 7.30 at the St. John Ambulance Hall, Asfordby Hill.

Wellingborough.—The March programme of the Wellingborough Radio Club, which meets each Thursday at 7.45 at the Silver Street Club Room, includes a lecture on electronic organs by F. Wright (4th) and another on electronics in the modern car by J. Baker (18th).

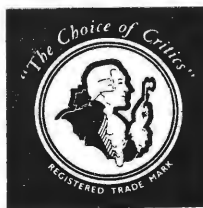

**THE HOUSE OF BULGIN
AT YOUR SERVICE**

**NEW COMPONENTS
FOR
IMMEDIATE DELIVERY**



List No: M.P.22/TERM

MINIATURE RECTANGULAR METER-PUSH
Simple to fit Press-for-ON Switch or Signalling Push; self-retaining in a rectangular panel hole 9.5mm. x 14.5mm. (0.374in. x 0.571in.). Groups of these pushes can be banked into larger holes for minimum panel areas. Operating button can be engraved to customer's requirements. Send for leaflet 1522/C.



List No: D.920/LEGEND

MAINS OPERATED MESSAGE INDICATOR
Specially designed to allow for permanently visible messages with Translucent background illuminating in Red and Green and a light separation barrier between. The illumination is supplied by Red and Green Neons operating at 200-250 V. A.C. only. No transformer or dropper, and no heat. Legending to customers own requirements.

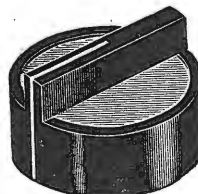

List No: K.491

KNOB WITH DECOR INSERTS
A unique range of Instrument Control Knobs with “Double-D” inset metal decor discs, for single or matched pair uses. Highly polished black mouldings with “spin” disc as standard or matt “silver” decor alternative. Radial 4BA. grub-screw, for nominal 1/4 shafts.

3WW-135 FOR FURTHER DETAILS.



List No: K.495

HIGHLY POLISHED BLACK KNOBS
Further new and Unique Knobs, with “silver matt” metal sleeve decor. Useful, efficient, neat and modern these also take 1/4 nominal shafts and have 4BA. radial grub-screw. Considerable torque can be conveyed, and precise angular adjustment or control is easily effected.

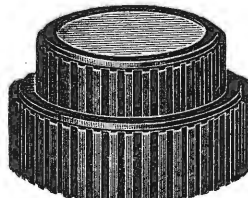

List No: K.504

SINGLE OR CONCENTRIC FIXING KNOBS
Range of four sizes of matching Knobs, black, ribbed and fitted with “spin” decor disc insert as standard. Each Knob can have a choice of shaft-bore Ø. All have radial 4BA. grub-screw for fixing. Range of sizes and shaft Ø allows use for concentric-pair shafts as illustrated.

FOR INSTALLATION DRAWINGS
OF THE COMPONENTS ILLUSTRATED,
QUOTE LIST No. —/C

A. F. BULGIN & CO. LTD.,
Bye Pass Rd., Barking, Essex.
Tel: RIPpleway 5588 (12 lines)

MANUFACTURERS AND SUPPLIERS OF RADIO
AND ELECTRONIC COMPONENTS TO

ADMIRALTY	MINISTRY OF WORKS	B.B.C.
WAR OFFICE	MINISTRY OF AVIATION	G.P.O.
AIR MINISTRY	MINISTRY OF SUPPLY	I.T.A.
HOME OFFICE	RESEARCH ESTABLISHMENTS	N.P.L.
CROWN AGENTS	U.K.A.E.A.	D.S.I.R.

3WW-135 FOR FURTHER DETAILS.

"A Team of Little Atomies"

SOMEWHERE, in a small back room in the heart of the electronics industry, sits little old Mrs. Malaprop, whose function in life is to provide christening names for her masters' brain-children.

The dear old soul has been at it for a very long time now. One of her earliest triumphs was the word "wireless," which clearly derives from her younger days when she was addicted to gallivanting around the countryside in a "horseless." "Electronics" is another of her bright ideas, dreamed up at a much later period, and patently on a day when the old lady had had one of her turns and wasn't feeling up to it.

But among her masterpieces are the comparatively modern ones "microelectronics," "microminiaturization" and "microcircuit." Oh what jolly fun the industry is going to have with these in the years to come! And what a Pandora's box of trials and tribulations was opened to us on the day of their birth! The latter aspect must wait, however, for another issue; for the moment, let us discourse upon the words themselves, and particularly upon Mrs. Malaprop's monumental sabotage of scientific exactitude.

I once knew a man who eked out a living as a professional Horrible Example at temperance meetings. The term "microelectronics" can serve us in the same stead, as indicative of what is going on around us in the matter of the invention of inconsequential new terminology.

Here then, we have sitting on our platform an expression which specifically evokes an image of something which is microscopically small. Nothing more than that. Just something fantastically tiny. Now this would be wonderful if only small size happened to be the vital feature of the new technology. But of course it is not. It is only incidental. And in any case a mere description of size is always prone to land us in awkward situations later on; there may, for instance, come a day when we are faced with the necessity of using "submicrominiaturization" or some other equally dreadful word. Conversely, if integrated circuit techniques should ever break through into the realm of power amplifiers we might then want to go up the scale in size-description. This would be rather like a circus billing of a normally sized man as "the world's tallest dwarf."

There is one vital technical feature which distinguishes microelectronics from all else, and that is not small size. It is Reliability with a capital R. This realization puts an entirely new complexion on things, because whereas small size is of interest in a few specialist fields of electronics, reliability is everybody's business. It is the lack of this invisible component which makes engineers mutter restlessly in their sleep and gives them premature ulcers.

This reliability feature is no empty advertising boast; it is very real, being inherent in the technology. It is not there because of any built-in magical property of silicon or any of the other possible materials, but for very simple reasons. One of these is that, compared with the number and variety of the processes and controls involved in the making of conventional circuits from discrete components, "micromin" has relatively few.

Again, when one remembers that most conventional components which fail in normal service do so because of interconnection faults (particularly where dissimilar metals are joined) or because of contamination in one form or another, the moral is clear. Keep interconnections down to the minimum and contamination away and—Abracadabra!—the reliability factor shoots toward the top of the charts. Micro-electronic techniques do just those very things; the solidity and low mass of the circuits increase the factor still further. What a series of selling points!

And what has dear old Mrs Malaprop done about it? By attaching that grossly misleading label "microelectronics" she has implied to all and sundry that here we have a blood-

relation to miniature and subminiature techniques and that it is therefore of potential interest only to the minority who want something even smaller than they have already got.

So far the damage done is slight although it might be sobering to know how many engineers already swamped with masses of technical information have skipped papers on microelectronics as being right out of their field of interest. But what of the customer's reaction when the time comes to sell him micromin equipment? The other industries have always been chary of embodying electronic equipment into their systems ("fragile and temperamental stuff") and only in recent years have significant dents been made in this armour of doubt. Now, Mrs. Malaprop has presented them with something they can really chew upon—a label which shrieks of ultra-tinness and, therefore, to the lay mind, of delicate health.

Oh, yes—you can prove to the customer that the two are not necessarily synonymous. You can get him to put a speck of dust into a strong metal box and then drop it from three miles up on to a concrete bed to demonstrate which emerges undamaged from the situation—the dust, the box or the concrete. But why bother, when the whole thing could be avoided by a change of label?

I know there must be many who are burning to chip in to say that the term microelectronics originated as a perfectly valid expression; valid because in the first instance the research objective was to produce the smallest possible circuits for use in things like proximity fuses and, later, for guided weapon and space ironmongery. That is true, but the real drive came when the reliability aspect was appreciated. And from that moment onward the terminology lost its significance.

The unpalatable fact is that we are all Mrs. Malaprops. The terminology which is coined in the laboratories may be perfectly adequate for internal use, but it isn't always so when it emerges into the world, and particularly the commercial world. And if that isn't bad enough, along come the technical committees and sit on our addled eggs, solemnly trying to hatch a definition out of them. If you think this is an exaggeration, consider our Horrible Example, "microelectronics" which has been with us for quite a number of years now. Committee after committee have brooded over this one and still continue to do so; but try to find an internationally—or even nationally—accepted definition and you will seek in vain because there isn't one.

The provisional one issued by a Technical Committee of the International Electrotechnical Commission (TC47) is:—

"That entire body of technology which is associated with, or applied to, the realization of electronic circuits with a degree of miniaturization greater than that usually obtained with conventional methods and/or parts."

By this standard a sub-sub-miniature component qualifies as micromin. You see how the fallacy is in danger of being perpetuated? How often is "usually"? How long is a piece of string?

And why hasn't an accepted definition been produced? To a simple mind (my nearest and dearest have cruder expressions for it) the answer is as plain as a pikestaff. The terminology is wrong in the first place. But why should the committee be hypnotized by our throw-away expressions? Why on earth can't they hold an inquest on the word itself in the first place, and ruthlessly sling it out if it doesn't add up, substituting one which is capable of definition?

There are, after all, many possible approaches; the "initials" gambit, for instance (as in MASER). Or, if a standard unit of reliability were devised both conventional and micromin techniques could be categorized (and readily recognized for what they were). But that is getting down to detail. Our immediate slogan should be "Mrs. Malaprop must go!"